



The International Fire Safety Equipment Supplier

Product Catalogue





Welcome to the latest IST product catalogue. Our catalogue contains hundreds of products from the industry's leading brands. We can only list the most popular items so if you can't find what you're looking for please don't hesitate to get in touch.

Many of the items listed are available from stock for speedy delivery and our efficient & effective logistics operation can provide email or text delivery information, 1 hour delivery slots and real time parcel tracking.

All the products listed in this catalogue can now be ordered online. If you are new to IST simply jump onto our website and register. If you would like to enquire about opening a credit account, please get in touch. We should be able to get the account open within 2 hours so you can start ordering online, against your account, straight away.

Our helpful customer service team are always on hand to answer any questions so give us a call.

To place an order:

Telephone: +44 (0) 1895 424505

email: orders@istsupplies.com

NOW ORDER ONLINE

FOR YOUR CONVENIENCE & SPEED

- ✓ Convenient ordering 24/7
- ✓ Check stock levels in real time
- ✓ View your order history
- ✓ Download invoices & statements



www.istsupplies.com

We can also supply:



please enquire

CONTENTS

CONTROL PANELS 2-15

Addressable - Residential - Conventional - Two Wire - Extinguishant Release - Marine Approved - AOV

POWER SUPPLIES 16-17

Approved Power Supplies - Transformer Rectifier Units - Battery Cabinets

RELAYS & PERIPHERALS 18

Boxed Relays - Relay Cards - Mains Isolate Switches - Sounder CCT Extension Card - Document Box & Log Book

CABLE & ACCESSORIES 19

Fireproof Cable - Cable Glands - Linian Fire Clips - Cable Clips - Cable Ties - Safe-D Clips

BATTERIES 20-21

Yuasa Sealed Lead Acid - Nickel Cadmium

WIRELESS FIRE ALARM 22-23

Hyfire - Zerio Plus

EMERGENCY & ASSISTANCE 24-31

Disabled Refuge Alarm (EVC) - Nursecall - Disabled Toilet Alarm - Vibrating Pillow Pad - Hearing Loop Systems

APOLLO DETECTION EQUIPMENT 32-38



apollo

NITTAN DETECTION EQUIPMENT 39



NITTAN

HOCHIKI DETECTION EQUIPMENT 40-42



HOCHIKI

ARGUS DETECTION EQUIPMENT 43



ARGUS SECURITY
intelligent fire solutions

BEAM DETECTORS 44-45

Firebeam - OSID - Fireray

ASPIRATING DETECTION 46-48

VESDA Aspirating Detectors - Accessories & Pipework - AirSense Aspirating Detectors & Pipework

DOMESTIC DETECTORS 49

Aico RadioLink Professional Residential Detectors & Accessories

LINEAR HEAT & WATER DETECTION 50-51

Signaline Linear Heat Detection - Signaline Linear Water Detection

HAZARDOUS AREA EQUIPMENT 52-53

Intrinsically Safe - Flameproof - Talentum Flame Detectors - Micropack Flame Detectors

SERVICING EQUIPMENT 54-57

Solo - Testifire - Scorpion

MANUAL CALL POINTS 58-61

KAC - Cooper Fulleon - STI - Stopper Covers

SOUNDERS & BEACONS 62-66

EN54-23 Approved Visual Alarm Devices (VADs) - Cooper Fulleon - Cranford Controls - Klaxon - VimpeX

MARINE APPROVED SYSTEMS 67

Marine Control Panels - Marine System Devices

AOV SYSTEMS 68-69

AOV Control Panels - Smoke Vent Call Points & Switches - Rain Sensor - PIR - Window Actuators

DOOR CONTROL 70-76

Magnetic Door Retainers - Wireless Door Retainers - Door Closers - Access Control

PROTECTIVE COVERS & CAGES 77

Protective Cages - Polycarbonate Covers - Stopper Alarms

EMERGENCY LIGHTING 78-80

Self Contained Emergency Light Fittings

ELAN ANALOGUE ADDRESSABLE CONTROL PANELS

Elan is the next generation of analogue addressable fire alarm control panels that are fully compliant with EN54 parts 2, 4 & 13 and CE marked under the Construction Products Regulation (CPR).

The panels have been designed to be flexible and powerful with an intuitive user interface including a high resolution graphical LCD display.

ELAN®

HS-5100 - 1 Loop Control Panels

Description	Part No	List Price	Usual Delivery
Single loop, small enclosure	HS-5101	£1236.62	Stock
Single loop, medium enclosure	HS-5101M	£1430.15	Stock



HS-5200 - 1 to 2 Loop Control Panels

Description	Part No	List Price	Usual Delivery
One loop, medium enclosure	HS-5201	£1672.48	Stock



Add loop driver cards (HSP-502) to expand up to 2 loops

HS-5400 - 1 to 4 Loop Control Panels

Description	Part No	List Price	Usual Delivery
One loop, large enclosure	HS-5401	£2382.01	Stock



Add loop driver cards (HSP-502) to expand up to 4 loops

HS-5800 - 2 to 8 Loop Control Panels

Description	Part No	List Price	Usual Delivery
Two loop, extended enclosure	HS-5802	£5440.40	Stock
Two loop, fault tolerant network, extended enclosure	HS-5802-FT	£6235.74	1 Week



Add loop driver cards (HSP-502) to expand up to 8 loops

ELAN REMOTE TERMINALS

Elan Remote Terminals

Description	Part No	List Price	Usual Delivery
Remote Display terminal with std network interface (RDT)	HS-5010	£824.42	Stock
Remote Control terminal with std network interface (RCT)	HS-5020	£1013.62	Stock
Remote Display terminal with fault tolerant network interface (RDT)	HS-5010-FT	£1554.23	3 Working Days
Remote Control terminal with fault tolerant network interface (RCT)	HS-5020-FT	£1756.95	3 Working Days



Elan TouchControl Remote Terminals

Description	Part No	List Price	Usual Delivery
Touch screen terminal, std network	TOUCH-10	£3015.76	1 Week
Touch screen terminal, fault tolerant	TOUCH-10-FT	£3803.58	1 Week
Surface back box	TOUCH-10-SBB	£105.28	1 Week



ELAN ACCESSORIES
Elan Network Cards

Description	Part No.	List Price	Usual Delivery
Standard network card	HSP-503	£297.32	Stock
Fault tolerant network card	HSP-509	£844.69	Stock

Elan Additional LED Indicators - suitable for large enclosures only

Description	Part No.	List Price	Usual Delivery
50 Zone FIRE (RED) - Large enc	HSP-513L-050RD	£303.08	Stock
100 Zone FIRE (RED) - Large enc	HSP-513L-100RD	£425.19	1 Week
200 Zone - Large enc (RED/YEL)	HSP-513L-200RY	£579.79	1 Week

Elan Peripherals

Description	Part No.	List Price	Usual Delivery
Loop driver card - Apollo, Hochiki	HSP-502	£253.41	Stock
Access enable key switch assembly	HSP-511	£91.50	Stock
On-board printer assembly	HSP-512	£554.95	Stock
Peripheral Bus - 4 way sounder card	MPX-034	£452.33	1 Week
Peripheral Bus - 4 way relay card	MPX-035	£403.43	1 Week
P-BUS 8-Way conventional zone card	HSP-536	£619.31	1 Week

Recessing Bezels

Description	Part No.	List Price	Usual Delivery
Recessing bezel for small enclosure control panels	HSM-501	£81.61	1 Week
Recessing bezel for medium enclosure control panels	HSM-502	£85.69	1 Week
Recessing bezel for large enclosure control panels	HSM-503	£91.83	1 Week
Recessing bezel for remote terminals	HSM-521	£71.42	1 Week
Recessing bezel for extended enclosure (8 loop control panels)	HSM-536	£171.31	1 Week

PC-NET Programming Software

Description	Part No.	List Price	Usual Delivery
Configuration software & lead	PC-NET-003	£172.91	Stock
Configuration software & USB upload/download lead	PC-NET-003-USB	£243.39	Stock
Remote dial-up software (virtual panel)	PC-NET-004	£849.73	1 Week
Logo programming software	PC-NET-007	£165.38	1 Week
Servicing Tool	PC-NET-015	£175.34	1 Week

Elan AlarmCalm Acknowledgement Button

Description	Part No.	List Price	Usual Delivery
AlarmCalm intelligent alarm acknowledgement button	HSP-541A-002	£123.26	1 Week

Elan Key Switch Control

Description	Part No.	List Price	Usual Delivery
2 position key switch (trapped)	HSP-516	£91.50	1 Week
2 position key switch (untrapped)	HSP-517	£91.50	1 Week
3 position key switch (trapped)	HSP-515	£83.93	1 Week



ELAN IP GATEWAY

ipGateway provides a secure, remote internet connection to an Elan fire system via a standard web browser. No special software is required.

The state of each device on the network is displayed and users can Enable/Disable zones, Enable/Disable devices, Reset, Mute, and Silence/Resound sounders on the network.

Elan ipGateway

Description	Part No	List Price	Usual Delivery
ipGateway interface (card only)	MXP-554	£923.33	1 Week
ipGateway interface (card only) fault tolerant	MXP-554-FT	£1803.86	1 Week
ipGateway interface (boxed)	MXP-554-BX	£1137.27	1 Week



ELAN GRAPHICAL INTERFACE

The Graphical Control Software is a highly configurable solution to customers requiring presentation of their sites via a Graphical method.

End users are presented with site maps, buttons, text, and images to easily monitor, navigate, and control the fire alarm equipment installed on-site.

Elan Graphical Interface

Description	Part No	List Price	Usual Delivery
BMS/Graphics interface (card only)	MXP-510	£712.79	1 Week
BMS/Graphics interface (card only) fault tolerant	MXP-510-FT	£1574.17	1 Week
BMS/Graphics interface (boxed)	MXP-510-BX	£907.55	1 Week
BMS/Graphics interface (boxed) fault tolerant	MXP-510-BX-FT	£1768.98	1 Week

PC-NET Software required



LIFELINE RADIO PAGING SYSTEM

LifeLine is three radio paging systems in one and can operate from any stand alone conventional or addressable panel or across a large addressable network and is quickly integrated via an ESPA card (for detailed fire paging) or a simple relay connection (for hearing impaired alerts).

Lifeline Radio Paging

Description	Part No	List Price	Usual Delivery
LifeLine 2W control panel	PX-100	£4479.27	1 Week
LifeLine vibrating pager unit	LL-PG	£344.25	1 Week
LifeLine vibrating pager unit with Out of Range enabled	LL-PG-01	£344.25	1 Week
LifeLine engineering pager	LL-PG-02	£344.25	1 Week
SleepCOM bedside unit & vibrating pillow pad	LL-SC	£971.91	1 Week
ESPA pager interface for Elan	MXP-547	£1240.85	1 Week
ESPA pager interface for Elan, boxed	MXP-547-BX	£1378.24	1 Week
Recessing bezel for PX-100	PXM-001	£116.41	1 Week



! As with all radio equipment, a site survey and detailed report must be carried out by a suitably qualified person, prior to any installation. Please contact us for further details.

MXPRO 4 ANALOGUE ADDRESSABLE CONTROL PANELS

The Mx Pro 4 range of analogue addressable control panels is available from 1 to 8 loops and boasts a huge array of dedicated peripherals, including on-board printers, network cards and input/output cards.

MxPro 4 Range

Description	Part No	List Price	Usual Delivery
Single loop, non extendable	MX-4100	£1553.28	1 Week
Single loop, extendable to two loops	MX-4201	£1998.36	1 Week
Two loop, non extendable	MX-4202	£2278.75	1 Week
One loop, extendable to four loops	MX-4401	£2806.14	1 Week
Four loop non extenable	MX-4404	£3645.09	1 Week

Other MxPro models available, POA

MxPro⁴
MXPRO 4 REMOTE TERMINALS

Description	Part No	List Price	Usual Delivery
Remote Display terminal with std network interface	MX-4010	£941.32	1 Week
Remote Control terminal with std network interface	MX-4020	£1179.44	1 Week
Remote Display terminal with fault tolerant network interface	MX-4010-FT	£1835.89	1 Week
Remote Control terminal with fault tolerant network interface	MX-4020-FT	£2074.01	1 Week

MXPRO 4 PERIPHERALS

Description	Part No.	List Price	Usual Delivery
Standard network card	MXP-003(F)	£354.62	1 Week
Fault tolerant network card	MXP-009(F)	£885.47	1 Week
Loop driver card (Apollo/Hochiki)	MXP-002	£252.49	1 Week
Access enable key switch assembly	MXP-011	£95.98	1 Week
Access enable key switch assembly factory fitted to panel	MXP-011F	£138.74	1 Week
100 way zone LED card factory fitted to panel	MXP-013-100F	£545.77	1 Week
Configuration software & lead	PC-NET-003	£172.91	1 Week
Configuration software & USB upload/download lead	PC-NET-003-USB	£243.39	1 Week

Other peripherals available, POA

GO SINGLE LOOP ANALOGUE ADDRESSABLE CONTROL PANELS
GO Range

Description	Part No	List Price	Usual Delivery
Single loop, 50 addresses	GO1	£877.50	1 Week
Single loop, 126 addresses	GO1+	£1053.00	1 Week
GO1 PBUS adaptor card	GOP-001	£140.40	1 Week
Routing termination card	MXP-506	£135.46	1 Week
Routing protection / interface	MXP-532	£342.55	1 Week

Go
NEW

COMELIT ANALOGUE ADDRESSABLE CONTROL PANELS & ACCESSORIES

LogiFire Easy 1 - 2 Loop Control Panel

Description	Part No.	List Price	Usual Delivery
LogiFire panel 1-2 loops (1 loop included)	41CPE112	£958.13	Stock
1 loop expansion card for LogiFire Easy 41CPE112	41ECL022	£224.00	Stock



LogiFire 1 - 4 Loop Control Panel

Description	Part No.	List Price	Usual Delivery
LogiFire panel 1-4 loops (1 loop card included)	41CPE118	£1977.66	Stock
1 loop expansion card for LogiFire 41CPE118	41ECL120	£333.97	Stock
Expander box 1- 4 loop for 41CPE118 with PSU (1 loop included)	41CPE104	£1069.21	Stock



Repeater Panel

Description	Part No.	List Price	Usual Delivery
Repeater panel for LogiFire	41CPR100	£752.83	Stock
Desk mount kit for 41CPR100	41KPR101	£175.80	Stock
Flush mounting kit for 41CPR100	41KPR102	£131.36	Stock
RS485 network card for 41CPE112 and 41CPE118 LogiFire panels	41ECB000	£205.03	Stock



Addressable Devices

Description	Part No.	List Price	Usual Delivery
Addressable optical smoke detector with isolator	41RFU100	£48.54	Stock
Addressable heat detector with isolator	41RCS100	£45.38	Stock
Addressable multisensor detector with isolator	41RML100	£56.55	Stock
Standard addressable base	41RBX020	£4.53	Stock
Addressable manual call point with isolator	41PAM000	£49.00	Stock
Loop powered sounder base	41SAB100	£61.23	Stock
Loop powered wall sounder	41SAI000	£51.49	Stock
Loop powered sounder/beacon vad en54-23	41SCI000	£82.54	Stock
Loop powered sounder base/strobe	41SCB100	£67.55	Stock
Remote indicator	48FPT100	£10.00	Stock
Module 2 inputs + 2 relays with isolator (big box)	41IOM022XL	£92.30	Stock



Programming Device

Description	Part No.	List Price	Usual Delivery
Programming device for addressable devices	41SPG000EN	£292.34	Stock



Beam Detectors

Description	Part No.	List Price	Usual Delivery
Conventional beam detector 50-100m with reflector	48BFC003	£848.95	Stock
Conventional beam detector 5-50m with reflector	48BFC002	£673.10	Stock



Enquire for conventional kits by Comelit

KENTEC SYNCRO-AS ANALOGUE ADDRESSABLE CONTROL PANELS

Syncro-AS combines compact and practical styling with the programming power and connectivity normally associated with much larger systems. It supports Apollo, Argus Vega and Hochiki detection, making it ideal for small and medium sites that require advanced fire sensing and evacuation options.



Syncro-As Lite Single Loop Control Panels

Description	Part No.	List Price	Usual Delivery
Syncro AS Lite - Apollo	LA81161M2	£762.90	1 Week
Syncro AS Lite c/w enable key - Apollo	LA80161M2	£858.25	1 Week
Syncro AS Lite - Hochiki	LH81161M2	£762.90	1 Week
Syncro AS Lite c/w enable key - Hochiki	LH80161M2	£858.25	1 Week



Syncro-As Single Loop Control Panels - Expandable to 2 Loops

Description	Part No.	List Price	Usual Delivery
Syncro AS 1 loop - Apollo	A81161M2	£961.56	1 Week
Syncro AS 1 loop c/w enable key - Apollo	A80161M2	£1025.15	1 Week
Syncro AS 1 loop - Hochiki	H81161M2	£961.56	1 Week
Syncro AS 1 loop c/w enable key - Hochiki	H80161M2	£1025.15	1 Week



Syncro-As Accessories

Description	Part No.	List Price	Usual Delivery
Syncro View LCD repeater (no PSU)	K67000M1	£635.74	1 Week
Syncro View LCD repeater with enable key (no PSU)	K67001M1	£676.12	1 Week
Syncro AS loop card - Apollo	K586A	£516.56	1 Week
Syncro AS loop card - Hochiki	K586H	£516.56	1 Week
Syncro AS fault tolerant network card	K555	£437.09	1 Week
Software download lead for Syncro panels	S187	£134.30	1 Week



C-TEC XFP ANALOGUE ADDRESSABLE CONTROL PANELS

The C-Tec XFP range of analogue addressable control panels offer high performance at a competitive price. Available as a cost effective single loop, 16 zone panel in a plastic enclosure or as a robust 1 or 2 loop, 32 zone panel in a metal cabinet. Both versions are fully compatible with Apollo's XP95/Discovery and Hochiki's ESP protocols.



XFP Range

Description	Part No	List Price	Usual Delivery
XFP single loop, 16 zone, XP95/Discovery protocol	XFP501E-X	£566.07	Stock
XFP single loop, 16 zone, Hochiki ESP protocol	XFP501E-H	£566.07	1 Week
XFP one loop, 32 zone, XP95/Discovery protocol	XFP501-X	£768.22	Stock
XFP two loop, 32 zone, XP95/Discovery protocol	XFP502-X	£965.77	1 Week
XFP two loop, 32 zone, Hochiki ESP protocol	XFP502-H	£965.77	1 Week
XFP network communication card for 16 zone control panels	CFP761	£91.97	1 Week
XFP network communication card for 32 zone control panels	AFP711	£138.97	1 Week
XFP configuration software kit (all protocols), includes download lead	XFP507	£143.87	Stock
XFP programming lead only, 2m	SAF7070000	£26.65	Stock



C-TEC BS5839-6 HUSH BUTTONS

A BS 5839-6 compliant fire alarm solution for houses in multiple occupation. Designed to sit on an Apollo or Hochiki analogue addressable loop, each Hush Button has its own conventional detector circuit, conventional sounder circuit and on-board loop isolator.

Provides each HMO dwelling with a two-minute silence facility and a 15 minute isolate facility, putting occupants firmly in control of their own fire alarm systems.

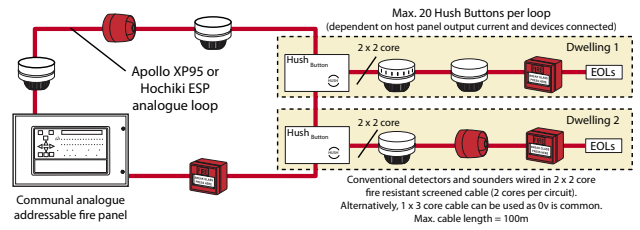

Description	Part No	List Price	Usual Delivery
Hush Button, Apollo XP95/Discovery	XFP508X	£99.48	1 Week
Hush Button, Hochiki ESP	XFP508H	£99.48	1 Week



Houses in Multiple Occupation (HMO's)



When a house is let to sharing occupants who are not a family unit, landlords must ensure that the property complies with rules around Houses in Multiple Occupation (HMO).

What is HMO?

A rented property is considered a House in Multiple Occupation if:

A property is occupied by five or more people, forming two or more households, who also share facilities such as the kitchen or bathroom, regardless of the number of storeys the property has.

C-TEC HUSH-ACTIVE BS5839-6 STAND ALONE KITS

Conventional stand-alone Grade C domestic fire detection and alarm systems to BS 5839-6 (2019) for use in individual flats, houses and apartments

- ✓ Includes all of the devices you need to create a typical LD2 dwelling system (additional devices available to accommodate larger systems)
- ✓ Monitored for head removal & open/short circuit faults



Description	Part No	List Price	Usual Delivery
Hush-Active BS5839-6 kit 1	HAK-1	£349.54	1 Week
Hush-Active BS5839-6 kit 2	HAK-2	£346.06	1 Week



C-TEC EVAC ALERT - BS 8629 EVACUATION ALERT SYSTEM

Introducing EVAC-ALERT - a new BS-8629 compliant evacuation alert system from C-TEC specifically designed to assist the fire & rescue services (FRS) in evacuating high-rise residential buildings.

- ✓ Can be used to create a simple-to-use, fully BS 8629 compliant, building specific evacuation alert system
- ✓ Manual controls allow the FRS to operate evacuation alert devices located inside flats on a zone by zone or floor by floor basis



Description	Part No	List Price	Usual Delivery
EAP 1 loop, 8 zone EVAC-ALERT panel - chassis only	EAP1-8CA-CHASSIS	£4267.08	1 Week
EAP 2 loop, 8 zone EVAC-ALERT panel - chassis only	EAP2-8CA-CHASSIS	£4472.88	1 Week
EACIE outer cabinet-includes lock & mounting bracket	EAPBOX	£4800.01	1 Week
EACIE 8 zone switch / indicator pcb	EAP8SWITCH	£851.20	1 Week
EACIE status pcb	EAPSTATUS	£103.04	1 Week
EACIE EN54-3 24v wall sndr - shallow base, red	BF430C-EA-SR	£103.18	1 Week
EACIE EN54-3 24v wall sndr - shallow base, white	BF430C-EA-SW	£103.18	1 Week
EACIE EN54-3 24v wall sndr/vid - shallow base, red	BF433C-EA-SR	£181.61	1 Week
EACIE EN54-3 24v wall sndr/vid - shallow base, white	BF433C-EA-SW	£181.61	1 Week
EACIE 1 way flat interface - double gang	CA736	£163.52	1 Week
EACIE 4 way flat interface no psu extendable to 8	CA737	£470.40	1 Week
EACIE 4 way flat interface c/w psu extendable to 8	CA737PSU	£576.24	1 Week

Full range available. Please enquire



BS 8629

BS 8629:2019 is a new standard. It is the code of practice for the design, installation, commissioning, and maintenance of evacuation alert systems for use by fire and rescue services in buildings containing flats.

ADVANCED EVAC GO - BS 8629 EVACUATION ALERT SYSTEM



EvacGo
Evacuation
Alert System



Makes meeting
BS 8629 easy



CALL US FOR YOUR PROJECT QUOTE

HAES ESENTO CONVENTIONAL CONTROL PANELS

Haes' Esentto conventional control panels are LPCB certified to EN54-2/4 and include panels from 2 to 32 zones. The range provides many in-built features such as networking, false alarm management & Twin Wire selection. Fully functional repeater panels are available for most models plus an array of peripherals & accessories.

ESENTO®

Eclipse Control Panels

Description	Part No.	List Price	Usual Delivery
2 zone (not suitable for repeaters)	ECL-2	£247.04	Stock
4 zone (not suitable for repeaters)	ECL-4	£276.11	Stock
Recessing bezel	FMK-ECL	£60.73	Stock



Excel Control Panels

Description	Part No.	List Price	Usual Delivery
2 zone	XLEN-2	£331.75	Stock
4 zone	XLEN-4	£381.83	Stock
6 zone	XLEN-6	£444.42	Stock
8 zone	XLEN-8	£494.50	Stock
12 zone	XLEN-12	£619.69	Stock



Excel Accessories

Description	Part No.	List Price	Usual Delivery
4 way extension zone card with additional outputs & sndr ccts	TPCA04-H	£174.15	Stock
Recessing bezel for Excel-EN control panels	FMK-XLEN	£77.19	Stock
Comms card for repeater & network connections	TPCA05	£142.72	Stock
8 way output card	OPCARD-8	£169.01	Stock

Evoque Control Panels

Description	Part No.	List Price	Usual Delivery
16 zone	XL32-16	£1020.30	Stock
24 zone	XL32-24	£1333.27	Stock
32 zone	XL32-32	£1646.25	Stock
Recessing bezel for Excel-32 control panels	FMK-XL32	£93.65	Stock
Comms card for repeater & network connections	TPCA05	£142.72	Stock
8 way output card	OPCARD-8	£154.58	Stock



ESENTO Repeater Panels (Only for use with Excel or Evoque panels)

Description	Part No.	List Price	Usual Delivery
12 zone repeater panel	XLEN-R-12	£287.94	Stock
Recessing bezel for 12 zone repeater panel	FMK-ECL	£60.73	Stock
LCD remote display unit	XL-RDU	£508.44	Stock
Recessing bezel for XL-RDU	FMK-ES-03	£40.93	Stock



ESENTO Spares

Description	Part No.	List Price	Usual Delivery
Spare key for door lock (set of 2)	KEY801	£10.90	Stock
Spare key for 'Activate Controls' key switch (set of 2)	KEY134	£11.98	Stock



C-TEC CFP CONVENTIONAL CONTROL PANELS

C-TEC's CFP conventional fire panels are LPCB certified to EN54-2/4 and offer an array of user and installer-friendly features at a very competitive price. Supplied in an attractive flush or surface mountable plastic enclosure, the range includes Standard and Economy versions with optional repeaters & relay expansion cards.



CFP Standard Control Panels

Description	Part No.	List Price	Usual Delivery
2 zone	CFP702-4	£198.83	1 Week
4 zone	CFP704-4	£200.88	1 Week
8 zone	CFP708-4	£287.91	1 Week



CFP Standard Control Panel Accessories

Description	Part No.	List Price	Usual Delivery
CFP 8 zone repeater panel	CFP760	£254.44	1 Week
CFP network comms card for CFP760	CFP761	£91.97	1 Week
CFP relay output cards	CFP762	£73.42	1 Week



CFP Economy Control Panels

Description	Part No.	List Price	Usual Delivery
2 zone	CFP702E-4	£175.90	1 Week
4 zone	CFP704E-4	£198.83	1 Week
8 zone	CFP708E-4	£241.04	1 Week

SCOPE F-LINK RADIO LINKING FOR CONTROL PANELS

F-Link provides monitored radio linking between fire control panels. A system consists of two or more F-Link units working together to form a mesh network with each unit operating as both a transmitter and receiver. The radio link between units is monitored for faults in accordance with the relevant sections of BS5839-1:2017 (24.2b) and BSEN54-25:2008 (4.2.6).



There is an additional output on the Master unit for connection to an optional paging transmitter, which sends alarm and fault messages to pocket pagers.

F-Link Transceivers

Description	Part No.	List Price	Usual Delivery
Pair of F-Link transceivers c/w aerials	FLINK4KIT	£2574.00	1 Week
Additional F-Link transceiver c/w aerial	FLINK4	£1287.00	1 Week
F-Link programming kit	FLINK4PROG	£73.92	1 Week



Paging Expansion

Description	Part No.	List Price	Usual Delivery
Connexions 6 paging transmitter, mains	CX6FAC	£1131.00	1 Week
Connexions 6 paging transmitter, 12vdc	CX6FDC	£1081.08	1 Week
Geo Zoom 8/4 line text pager	GEO87ZM	£257.40	1 Week



Optional Aerials

Description	Part No.	List Price	Usual Delivery
Lightweight dipole aerial, SMA connector	LDPSMA	£73.23	1 Week
Folded dipole aerial kit, SMA connector	FDKIT10SMA	£307.32	1 Week



FIKE TWINFLEX 2 WIRE CONTROL PANELS & DEVICES

Fike's TWINFLEXpro² 2-wire fire alarm system has long been known for its adaptability and cost-effectiveness within a variety of applications, big or small ... making it one of the most flexible products on the market.

TWINFLEXpro²

Twinflex Pro2 Control Panels & Repeater

Description	Part No.	List Price	Usual Delivery
2 zone (non expandable, not suitable for repeater panel)	FK505-0002	£339.53	Stock
4 zone (expandable to 8 zones)	FK505-0004	£421.30	Stock
8 zone (non expandable)	FK505-0008	£580.16	Stock
Repeater panel (only suitable for 4 or 8 zone)	FK505-0010	£298.05	Stock
Twinflex 4 zone expansion card	FK505-0006	£210.01	Stock
Conventional 4 zone expansion card	FK505-0007	£209.98	1 Week
Twinflex Pro PC programming software	FK505-0040	£64.51	1 Week



Twinflex Multipoint ASD Detectors

Description	Part No.	List Price	Usual Delivery
Twinflex Multipoint ASD detector	FK204-0003	£50.80	Stock
Twinflex Multipoint ASD detector with sounder	FK204-0001	£60.95	Stock
Twinflex Multipoint ASD detector with sounder/strobe	FK204-0012	£95.26	Stock



Twinflex Manual Call Points

Description	Part No.	List Price	Usual Delivery
Twinflex manual call point	FK402-0006	£29.20	Stock
Twinflex weatherproof manual call point (IP65)	FK402-0007	£50.92	Stock



Twinflex Sounders

Description	Part No.	List Price	Usual Delivery
Twinflex Hatari sounder, red	FK302-0001	£28.93	Stock
Twinflex Hatari sounder, white	FK302-0002	£28.93	Stock
Twinflex Soundpoint, red	FK313-0021	£28.93	Stock
Twinflex Soundpoint, white	FK313-0022	£28.93	Stock
Twinflex Hi Point	FK302-0004	£57.44	Stock



Twinflex Sounder/Strobes & Module

Description	Part No.	List Price	Usual Delivery
Twinflex Flash Point, low profile	FK302-0012	£48.19	Stock
Twinflex Flash Point, domed	FK302-0022	£50.62	Stock
Twinflex Flash Point, weatherproof (beacon only)	FK302-0023	£69.48	Stock
Twinflex input/output module	FK802-0006	£97.02	Stock



Twinflex Accessories

Description	Part No.	List Price	Usual Delivery
Twinflex manual call point cover	FK25-0083-303	£8.66	Stock
Twinflex call point keys (pack of 5)	FK45-0022-S	£4.19	Stock
ASD head removal tool	FK25-0046-201	£15.72	Stock
Head removal key ring for ASD detectors	FK23-0244-510	£8.65	Stock



HAES ALARMSENSE CONTROL PANELS

Haes dedicated range of control panels suitable for Apollo's AlarmSense 2 wire protocol devices. The AlarmSense panel is available as a 2 or 4 zone while the AlarmSense PLUS is available with 4, 8 or 12 zones. A fully functional repeater panel is also available for the AlarmSense PLUS range.

AlarmSense Control Panels

Description	Part No.	List Price	Usual Delivery
2 zone	ALS-2	£247.04	Stock
4 zone	ALS-4	£276.11	Stock
Recessing bezel	FMK-ECL	£60.73	Stock

AlarmSense PLUS Control Panels

Description	Part No.	List Price	Usual Delivery
4 zone	ASP-4	£381.83	Stock
8 zone	ASP-8	£494.50	Stock
12 zone	ASP-12	£619.69	Stock
Recessing bezel	FMK-XLEN	£77.19	Stock
4 zone expansion card	TPCA07	£130.48	Stock
AlarmSense PLUS 12 way repeater panel	ASP-R-12	£287.94	Stock

C-TEC CFP ALARMSENSE CONTROL PANELS

C-TEC's LPCB-certified two-wire CFP AlarmSense fire panel is easy-to-install and fully compatible with Apollo's AlarmSense two-wire system components. Supplied in an attractive flush or surface mountable plastic enclosure, it includes 2, 4 or 8 AlarmSense zone circuits.

CFP AlarmSense Control Panels

Description	Part No.	List Price	Usual Delivery
2 zone	CFP702-2	£252.62	1 Week
4 zone	CFP704-2	£315.77	1 Week
8 zone	CFP708-2	£442.08	1 Week

CFP AlarmSense Control Panel Accessories

Description	Part No.	List Price	Usual Delivery
CFP 8 zone repeater panel	CFP760	£254.44	1 Week
CFP network comms card for CFP760	CFP761	£87.59	1 Week
CFP relay output cards	CFP762	£73.42	1 Week



See page 37 for AlarmSense devices



Extinguishant Control Panels

HAES ESPRIT EXTINGUISHANT RELEASE CONTROL PANELS

Haes Esprit-G Control Panels & Accessories

Description	Part No.	List Price	Usual Delivery
Single flood area, 3 detection zones control panel, 1.2A integral PSU	ESG-1001	£551.32	Stock
Single flood area, 3 detection zones control panel, 3.4A integral PSU	ESG-1002	£612.58	1 Week
Dual flood area, 6 detection zones control panel, 3.4A integral PSU	ESG-1003	£796.35	1 Week
Graphic display remote status unit	ESG-2001	£297.50	Stock
Compact remote status indicator	ESG-2002	£69.55	Stock
Remote Hold Off button - metal enclosure	ESG-2006	£91.89	Stock
Remote Abort button - metal enclosure	ESG-2007	£114.04	Stock

Full range of accessories available. Please enquire



C-TEC EXTINGUISHANT RELEASE CONTROL PANELS

C-Tec Control Panel & Accessories

Description	Part No.	List Price	Usual Delivery
C-Tec automatic extinguishant control panel	EP203	£703.01	1 Week
Remote status indicator, surface, with manual release & Auto/Manual key	EP210S	£298.84	1 Week
Economy remote status indicator	EP211	£155.75	1 Week
Hold/Abort button	EP215	£103.43	1 Week

Full range of accessories available. Please enquire



KENTEC EXTINGUISHANT RELEASE CONTROL PANELS

Kentec Sigma XT Control Panel & Accessories

Description	Part No.	List Price	Usual Delivery
Sigma XT extinguishant control panel	K11031M2	£794.68	1 Week
Sigma Si - 6 LED status unit c/w manual release & mode select switch	K911110M8	£222.50	1 Week
Sigma Si - hold off button, green button	K91000M10	£109.66	1 Week
Sigma Si - abort button	K13470M10	£109.66	1 Week

Full range of Sigma XT+, Syncro XT+ & accessories available. Please enquire



ADVANCED EX-GO EXTINGUISHANT RELEASE CONTROL PANELS

Advanced Ex-Go Control Panel & Accessories

Description	Part No.	List Price	Usual Delivery
Ex-Go automatic extinguishant control panel	EX-3001	£970.56	1 Week
Remote status indicator	EX-3031	£371.73	1 Week
Hold off button	EXP-003-001	£101.05	1 Week
Abort button	EXP-004-001	£101.05	1 Week

Full range of accessories available. Please enquire



MARINE APPROVED CONTROL PANELS

The Esento Marine range from Haes has been exclusively developed to address the issues of limited form and function in the conventional panels market for use at sea.

Esento Marine Control Panels

Description	Part No.	List Price	Usual Delivery
2 zone	ESEN-2MAR	£370.61	Stock
4 zone	ESEN-4MAR	£454.84	Stock
8 zone	ESEN-8MAR	£791.76	Stock
12 zone	ESEN-12MAR	£993.90	Stock
12 zone repeater panel	ESEN-R-12MAR	£377.75	Stock

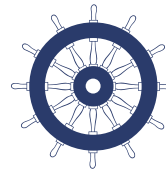

See page 67 for Marine Approved devices

AUTOMATIC OPENING VENT CONTROL PANELS

The Haes AOV control panel range has been developed to provide a comprehensive solution for the control of smoke ventilation systems.

Multi Zone AOV Automatic Opening Vent Control Panels

Description	Part No.	List Price	Usual Delivery
Single zone non extendable, 3A PSU	MZAOV-1001A	£611.00	Stock
2 zone, extendable to 4, 3A PSU	MZAOV-1001	£753.92	Stock
2 zone, extendable to 4, 5A PSU	MZAOV-1002	£904.15	Stock
2 zone, extendable to 8, 10A PSU	MZAOV-1003	£1431.34	Stock
2 zone extension card	MZAOV-3001	£208.65	Stock
PIR, Rain Sensor & BMS add on card	MZAOV-3002	£139.10	Stock

Single Zone AOV Automatic Opening Vent Control Panels

Description	Part No.	List Price	Usual Delivery
Single zone non extendable, 3A PSU	SZAOV-1001	£390.00	Stock



See page 68 for AOV system devices



APPROVED BATTERY CHARGER/POWER SUPPLIES



The Haes 1.5A, 3.0A and 5.0A, approved, power supply units can be used for any fire alarm system installation that specifies EN54-4 Power Supply Equipment.

The units are available in enclosures of various sizes to suit different battery capacities, providing power and fault indication.

- ✓ Switched mode power supplies
- ✓ Fully compliant to EN54-4
- ✓ Power and fault indication
- ✓ Wide AC input range on the 3.0A & 5.0A versions

Cabinet sizes :

- PSAS : 320H x 345W x 88D (mm)
- PSAM : 425H x 406W x 125D (mm)
- PSAL : 425H x 406W x 190D (mm)

EN54 Approved Battery Charger/Power Supplies

Description	Part No.	List Price	Usual Delivery
1.5 amp, 24vdc, small cabinet, space for up to 7Ah batteries	PSAS-15EN54	£228.24	Stock
3.0 amp, 24vdc, small cabinet, space for up to 7Ah batteries	PSAS-30EN54	£338.76	Stock
3.0 amp, 24vdc, medium cabinet, space for up to 18Ah batteries	PSAM-30EN54	£405.44	Stock
5.0 amp, 24vdc, medium cabinet, space for up to 18Ah batteries	PSAM-50EN54	£529.35	Stock
5.0 amp, 24vdc, large cabinet, space for up to 38Ah batteries	PSAL-50EN54	£574.39	Stock

APPROVED 10A BATTERY CHARGER/POWER SUPPLIES

The STX range of switch mode power supplies has been specifically designed for EN54 compliant fire systems.

The units include intelligent battery charging using Elmdene's efficient EcoCharge technology, and also feature battery deep discharge protection in the event of a prolonged mains failure.

- ✓ Cost effective switch mode technology
- ✓ Intelligent battery charging & monitoring
- ✓ Fully compliant to EN54-4
- ✓ Deep discharge protection

Cabinet sizes :

- E Model : 420H x 400W x 80D (mm)
- H Model : 420H x 420W x 180D (mm)



10 Amp EN54 Approved Battery Charger/Power Supplies

Description	Part No.	List Price	Usual Delivery
10 amp, 24vdc, E cabinet, space for up to 18Ah batteries	STX2410-E	£560.19	1 Week
10 amp, 24vdc, H cabinet, space for up to 38Ah batteries	STX2410-H	£607.37	1 Week

TRANSFORMER RECTIFIER POWER SUPPLIES

Haes 'TRX' transformer rectifier power supplies are suitable for applications requiring a simple regulated 24vdc supply, where the charging of standby batteries is not required.

- ✓ Regulated 24vdc supply
- ✓ Robust steel enclosure
- ✓ Integral load switching relay
- ✓ Continuously rated at design load
- ✓ Wide mains input voltage
- ✓ Overload protected

Ideal For

TRX Transformer Rectifier Power Supplies

Description	Part No.	List Price	Usual Delivery
24vdc, 0.7 amp continuous rating. Max current 1.0 amp	TRX0.7A-24	£73.51	Stock
24vdc, 1 amp continuous rating. Max current 1.5 amp	TRX1A-24	£91.89	Stock
24vdc, 2.5 amp continuous rating. Max current 3.2 amp	TRX2.5A-24	£107.20	Stock

BATTERY CABINETS

Two sizes of cabinet for the storage of batteries. The smaller cabinet can house up to 2 x 18Ah SLA batteries and the larger cabinet has capacity for up to 2 x 65Ah SLA batteries.

Cabinets are robust steel enclosures with lockable hinged doors.

Battery Cabinets

Description	Part No.	List Price	Usual Delivery
Small enclosure for up to 18Ah batteries	BC100	£133.59	Stock
Large enclosure for up to 65Ah batteries	BC200-5	£267.15	Stock

AUXILIARY RELAYS

Boxed Auxiliary Relay

24vdc 8 amp double pole relay

Description	Part No	List Price	Usual Delivery
Aux relay, red	BRF248A-R	£28.08	Stock
Aux isolate relay, red	BRISOL-R	£77.23	Stock



IP Rated Boxed Auxiliary Relay

24vdc double pole relay

Description	Part No	List Price	Usual Delivery
5A, 24vdc, double pole boxed relay	REBOX24-5	£34.33	Stock
8A, 24vdc, double pole boxed relay	REBOX24-10	£36.75	Stock



Timer/Pulsing Auxiliary Relay

24vdc 8 amp double pole relay

Description	Part No	List Price	Usual Delivery
Timer/pulsing relay, boxed version	BRTIMER	£78.26	Stock
Timer/pulsing relay, PCB only	RECARD-TMR	£61.98	Stock



Relay Card

Description	Part No	List Price	Usual Delivery
8A, 24vdc, double pole relay card	RECARD24-8F	£17.94	Stock



Lockdown Alarm Pulsing Relay

24vdc 8 amp double pole relay, customisable on/off pulsing times

Description	Part No	List Price	Usual Delivery
Lockdown alert relay	BRLDA	£101.71	Stock



PERIPHERALS

Fire Alarm Mains Isolate Switch

Description	Part No	List Price	Usual Delivery
Fire alarm isolator, red, c/w back box	FAIS-R-B	£27.09	Stock
Mains isolator in steel, single gang box	SW-MISOL	£37.26	Stock



Mains Filter

Description	Part No	List Price	Usual Delivery
Mains suppression filter	ACT230MSF	£47.22	Stock



Sounder Circuit Extension Card

Description	Part No	List Price	Usual Delivery
4 way sounder circuit extension card	SNDEXT-4	£92.56	Stock

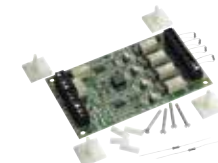

Document Box & Log Book

Description	Part No	List Price	Usual Delivery
A4 documents cabinet	A4-DOC-BOX	£32.11	Stock
Fire alarm system log book (A5)	LOGBOOK	£11.07	Stock



FIRE PERFORMANCE CABLE



Prysmian FP200 Cable, 100m Reels

Description	Part No	List Price	Usual Delivery
FP200 Gold, 2 core, 1.5mm, red	FP200-2C-1.5-R	£200.62	Stock
FP200 Gold, 2 core, 1.5mm, white	FP200-2C-1.5-W	£200.62	Stock
FP200 Gold, 4 core, 1.5mm, red	FP200-4C-1.5-R	£617.76	Stock
FP200 PLUS, 2 core, 1.5mm, red	FP200PLUS-2C-1.5-R	£485.58	1 Week



FIRE CABLE ACCESSORIES



Fire Cable Clips

Supplied in packs of 100

Description	Part No	List Price	Usual Delivery
Red fire clip, 6-8mm single (pack of 100)	1LCR608	£49.61	Stock
Red fire clip, 6-8mm double (pack of 100)	1LCR68-2	£59.16	Stock
Red fire clip, 9-11mm single (pack of 100)	1LCR911	£49.61	Stock
Red fire clip, 9-11mm double (pack of 100)	1LCR911-2	£59.16	Stock
White fire clip, 6-8mm single (pack of 100)	1LCW608	£49.61	Stock
White fire clip, 6-8mm double (pack of 100)	1LCW68-2	£59.16	Stock
White fire clip, 9-11mm single (pack of 100)	1LCW911	£49.61	Stock
White fire clip, 9-11mm double (pack of 100)	1LCW911-2	£59.16	Stock



Cable Glands

20mm Nylon cable glands, supplied in packs of 10

Description	Part No	List Price	Usual Delivery
Nylon cable gland, 20mm, red (pack of 10)	KGM120-R	£6.84	Stock
Nylon cable gland, 20mm, white (pack of 10)	KGM120-W	£6.84	Stock



Cable Clips

Fire cable 'P' clips & saddle clips, supplied in packs of 50

Description	Part No	List Price	Usual Delivery
50 x P clip, red, suitable for 2 core 1.5mm cable	VCA-C7SR	£20.41	Stock
50 x P clip, white, suitable for 2 core 1.5mm cable	VCA-C7SW	£14.20	Stock
50 x P clip, red, suitable for 4 core 1.5mm cable	VCA-C9SR	£15.85	Stock
50 x Saddle clips, suitable for 2 core 1.5mm cable	VCA-S8DR	£22.49	Stock



Cable Ties

Stainless steel & red Nylon cable ties, supplied in packs of 100

Description	Part No	List Price	Usual Delivery
100 x Nylon cable ties, red, 4.8 x 200mm	CT200RED	£7.76	Stock
100 x Nylon cable ties, red, 4.8 x 295mm	CT295RED	£10.41	Stock
100 x S/Steel cable ties, uncoated, 4.6 x 150mm	CT150SS	£39.91	Stock
100 x S/Steel cable ties, uncoated, 4.6 x 200mm	CT200SS	£57.65	Stock



Mini Trunking Safe-D Clips For compliance to BS5839 - 1:2013 "Methods of cable support"

Description	Part No	List Price	Usual Delivery
Fire cable clip - up to 30mm trunking - box of 50	SAFE-D30	£22.10	Stock
Fire cable clip - up to 40mm trunking - box of 50	SAFE-D40	£17.42	Stock
Fire cable clip - up to 50mm trunking - box of 50	SAFE-D50	£24.64	Stock



SEALED VALVE REGULATED LEAD ACID BATTERIES



The world's leading battery manufacturer

NP RANGE

Yuasa NP batteries are the most reliable batteries in the world, that's why industry professionals choose Yuasa over any other battery for security, fire and emergency lighting applications.



NP Sealed Lead Acid Batteries

Description	Dimensions L x W x H (mm)	Part No.	Box Qty	List Price	Usual Delivery
4Ah, 6 volt	70 x 47 x 105.5	NP4-6	20	£16.17 per battery	Stock
10Ah, 6 volt	151 x 50 x 97.5	NP10-6	10	£30.81 per battery	Stock
12Ah, 6 volt	151 x 50 x 97.5	NP12-6	10	£37.00 per battery	Stock
1.2Ah, 12 volt	97 x 48 x 54.5	NP1.2-12	20	£14.54 per battery	Stock
2.1Ah, 12 volt	178 x 34 x 64	NP2.1-12	20	£18.20 per battery	Stock
3.2Ah, 12 volt	134 x 67 x 64	NP3.2-12	12	£20.53 per battery	Stock
4.0Ah, 12 volt	90 x 70 x 106	NP4-12	10	£26.29 per battery	Stock
7.0Ah, 12 volt	151 x 65 x 97.5	NP7-12	8	£26.06 per battery	Stock
12Ah, 12 volt	151 x 98 x 97.5	NP12-12	4	£51.38 per battery	Stock
18Ah, 12 volt	180 x 76 x 167	NP18-12	4	£79.38 per battery	Stock
24Ah, 12 volt	166 x 175 x 125	NP24-12	2	£97.99 per battery	Stock
38Ah, 12 volt	197 x 165 x 170	NP38-12	1	£150.20 per battery	Stock
65Ah, 12 volt	350 x 166 x 174	NP65-12	1	£255.23 per battery	Stock

SEALED VALVE REGULATED LEAD ACID BATTERIES



Yucel Sealed Lead Acid Batteries

Description	Dimensions L x W x H (mm)	Part No.	Box Qty	List Price	Usual Delivery
1.2Ah, 12 volt	97 x 48 x 54.5	Y1.2-12	20	£11.81 per battery	Stock
2.1Ah, 12 volt	178 x 34 x 64	Y2.1-12	20	£16.81 per battery	Stock
3.2Ah, 12 volt	134 x 67 x 64	Y3.2-12	10	£17.99 per battery	Stock
4.0Ah, 12 volt	90 x 70 x 106	Y4-12	10	£21.81 per battery	Stock
7.0Ah, 12 volt	151 x 65 x 97.5	Y7-12	8	£23.46 per battery	Stock
9.0Ah, 12 volt	151 x 65 x 97.5	Y9-12	8	£30.55 per battery	Stock
12Ah, 12 volt	151 x 98 x 97.5	Y12-12	5	£46.98 per battery	Stock
17Ah, 12 volt	180 x 76 x 167	Y17-12	4	£67.65 per battery	Stock
24Ah, 12 volt	166 x 175 x 125	Y24-12	1	£90.33 per battery	Stock
38Ah, 12 volt	197 x 165 x 170	Y38-12	1	£141.24 per battery	Stock
65Ah, 12 volt	350 x 166 x 174	Y65-12	1	£262.56 per battery	Stock

SLA Battery Tester

Description	Part No	List Price	Usual Delivery
6v-12v SLA Battery Tester	ACT612	£505.90	Stock



NICKEL CADMIUM BATTERIES



'D' size, high temperature, Nickel Cadmium batteries. Sleeved in sticks and packs.

Supplied complete with flying leads.
(Stick = end to end, Pack = side by side)

Suitable for emergency lighting

Nickel Cadmium Batteries

Description	Part No.	List Price	Usual Delivery
Single cell, 4Ah, 1.2 volt (supplied with solder tags only)	NC400D	£5.30	Stock
2 cell stick, 4Ah, 2.4 volt with leads	NC2-400D1L	£10.82	Stock
2 cell pack, 4Ah, 2.4 volt with leads	NC2-400D2L	£10.82	Stock
3 cell stick, 4Ah, 3.6 volt with leads	NC3-400D1L	£16.28	Stock
3 cell pack, 4Ah, 3.6 volt with leads	NC3-400D2L	£16.28	Stock
4 cell stick, 4Ah, 4.8 volt with leads	NC4-400D1L	£21.68	Stock
4 cell pack, 4Ah, 4.8 volt with leads	NC4-400D2L	£21.68	Stock
5 cell stick, 4Ah, 6.0 volt with leads	NC5-400D1L	£27.08	Stock
5 cell pack, 4Ah, 6.0 volt with leads	NC5-400D2L	£27.08	Stock
NiCd 3*1.6Ah Htemp SubCcell Leads & Molex Plug Sty4	3SCH1-6LM4	£9.20	Stock

Replacement Batteries for ELTS-LED Twin Spot Emergency Lights

Description	Part No.	List Price	Usual Delivery
Battery pack for Haes ELTS-LED-D Twin Spot emergency light	ELTS-LED-D-BATT	£23.16	Stock





The worlds most advanced wireless fire solution



The Hyfire system raises wireless fire detection and alarm systems to new levels of reliability and flexibility. The system utilises the latest wireless technologies to provide rapid, yet economic wireless fire system installations with the minimum of disturbance to the surroundings.

With its fully wireless or hybrid capability and an impressive

range of field devices the system lends itself easily to a wide variety of applications.

The Hyfire system is equally at home protecting a sensitive heritage building, extending an existing wired system in a busy hotel environment or providing temporary protection for a building site.

HyFire Wireless Fire Detection

Description	Part No.	List Price	Usual Delivery
HyFire wireless translator module (loop powered)	HFW-W2W-01	£338.50	1 Week
HyFire wireless expander module (requires power supply)	HFW-EM-01	£338.50	1 Week
Wireless to conventional interface module (requires power supply)	HFW-CEM-02	£372.34	1 Week
Intelligent wireless optical smoke detector c/w base & batteries	HFW-PA-05	£249.64	1 Week
Intelligent wireless heat detector c/w base & batteries	HFW-TA-05	£241.20	1 Week
Intelligent wireless multi criteria detector c/w base & batteries	HFW-MA-05	£275.03	1 Week
Wireless manual call point c/w back box, batteries & cover	HFW-CP-03-C	£238.04	1 Week
Wireless single channel powered output module & batteries	HFW-BOM-03	£416.13	1 Week
Wireless base sounder	HFW-BS-05	£281.44	1 Week
Conventional wall sounder (red)	HFC-WSR-03	£64.45	1 Week
Conventional sounder beacon (red)	HFC-SBR-23-03	£106.65	1 Week
Wireless sounder interface module	HFW-SIM-01	£280.97	1 Week
Spare primary battery (pack of 10)	HFW-PB-01	£63.37	1 Week
Spare secondary battery (pack of 10)	HFW-SB-01	£35.78	1 Week

Haes Esprit-A Analogue Addressable Control Panels

Description	Part No.	List Price	Usual Delivery
One loop analogue addressable control panel (extendable to two loops) - Argus protocol	ESA-1001	£757.40	Stock
One loop analogue addressable control panel (extendable to four loops) - Argus protocol	ESA-1002	£1262.33	Stock
Loop extension card	ESA-3001	£306.02	Stock



Important Note:

As with all radio equipment, a site survey and detailed report must be carried out by a suitably qualified person, prior to any installation. Please contact us for further details.



Electro-Detectors



Zerio Plus

With 240 devices across a maximum of 100 zones, the Zerio Plus system offers the perfect solution for small domestic buildings up to large commercial premises.

Setting the system up could not be simpler. Each device is programmed onto the system using a clearly laid out user-friendly menu structure. There is no need to connect the device with a programming lead, as the configuration is achieved by radio.

Location descriptions can be added by using a PC or simply programmed using a standard PC keyboard plugged into the

panel or for a single device the in-built keypad.

With analogue detector functionality and complex multi-path fault tolerant signalling, the system minimises false alarms whilst providing maximum protection for the occupants of a building. In order to increase the radio range of the system, either wired or radio booster panels can be installed at appropriate positions.

Third party approved to EN54 Part 25.



Zerio Plus Wireless Fire Alarm System

Description	Part No.	List Price	Usual Delivery
8 zone Zerio Plus control panel	EDA-Z5008	£962.35	Stock
20 zone Zerio Plus control panel	EDA-Z5020	£1245.04	1 Week
Zerio Plus radio booster (requires 240v supply)	EDA-Z6000	£757.85	Stock
Zerio Plus wired booster unit	EDA-Z6010	£396.97	1 Week
Radio smoke detector	EDA-R5000	£238.18	Stock
Radio smoke detector with sounder	EDA-R6000	£451.10	Stock
Radio smoke detector with sounder and LED beacon	EDA-R6030	£526.89	Stock
Radio heat detector	EDA-D5000	£226.16	Stock
Radio heat detector with sounder	EDA-D6000	£435.46	Stock
Radio call point	EDA-C5000	£215.93	Stock
Radio sounder	EDA-A6000	£322.39	Stock
Radio sounder with LED beacon	EDA-A6030	£402.99	Stock
Radio input/output unit	EDA-T6080	£434.26	Stock
Battery assembly for Zerio and Millennium detectors	EDA-Q660	£26.58	Stock
Battery assembly for Millennium and Zerio devices	EDA-Q670	£26.58	Stock
Zerio Plus battery pack	EDA-Q690	£26.58	Stock

! Important Note:

As with all radio equipment, a site survey and detailed report must be carried out by a suitably qualified person, prior to any installation. Please contact us for further details.

HAESCOMM EMERGENCY VOICE COMMUNICATION SYSTEM



The Haescomm EVCS concept covers **Fire Telephone** and **Disabled Refuge Systems**, as well as integrating **Emergency Assist Alarm Systems** in a single solution.

The use of networking in every controller ensures scalability and removes redundancy on sites allowing them to evolve from single stand alone systems to complex site wide campus scenarios.



REFUGE ALARM

HAESCOMM TMS TOUCH SCREEN MASTER STATION

The HC-TMS network touch-screen controller has an integrated 2 to 8 line exchange and power supply, allowing control and connectivity in a single unit.

It can also integrate with HC-228 units. By using a touch screen, the operation of the panel is user friendly and intuitive.

- ✓ 4.3" full colour touch screen
- ✓ Integrated Assist Call with acknowledge
- ✓ Expandable from 2 to 512 lines with 64 network devices



Description	Part No.	List Price	Usual Delivery
Haescomm touchscreen master station	HC-TMS-W-8	£1706.51	Stock
Haescomm touchscreen repeater station	HC-TMS-W-0	£1545.75	1 Week

HAESCOMM 228 MASTER STATION

The HC-228 has an integrated 2 to 8 line exchange and power supply. Designed for ease of installation and commissioning, the HC-228 is a solution for smaller projects, but with built in networking it can form the local control element of complex campus style systems.

- ✓ Compact design
- ✓ Integrated Assist Call with acknowledge
- ✓ Expandable from 2 to 8 lines



Description	Part No.	List Price	Usual Delivery
Haescomm 2 line master station	HC-228-2	£1062.24	Stock
Haescomm 4 line master station	HC-228-4	£1112.94	Stock
Haescomm 8 line master station	HC-228-8	£1378.81	Stock
Haescomm repeater station	HC-228-0	£1022.67	Stock
Haescomm 2 Line Expansion Card For HC-228 Controllers	HC-LC2	£143.45	Stock
Recessing bezel for HC-228 controllers	HC-CBZ	£75.44	Stock

See page 26 for Integrated Emergency Assist Call



HAESCOMM SYSTEM EXPANDER

The HC-EX8 system expander panel can accept up to eight lines of outstation.

With in built networking it can form one of the 64 panels on a Haescomm network installation.



Description	Part No.	List Price	Usual Delivery
Haescomm 8 line system expander	HC-EX8-8	£921.27	Stock

The Haescomm Remote Alarm Panel provides a remote audible and visual indication of when an outstation or Assist Call is activated and is ideal for use where the master station is located within a non staffed area such as an entrance lobby.



Description	Part No.	List Price	Usual Delivery
Haescomm remote alarm panel	HC-RAP	£154.58	1 Week

HAESCOMM PC TOUCHSCREEN CONTROL

The Haescomm Commander is a touchscreen panel PC with inbuilt telephone handset and provides an interactive interface to the EVCS with high resolution maps or graphical representations.



Description	Part No.	List Price	Usual Delivery
Haescomm PC touch screen controller	HC-COMMANDER	£POA	1 Week

OUTSTATIONS

Type A outstations are primarily for use by the fire services in high-rise buildings to provide clear communications between the control point and the fire fighters.

Type B outstations are primarily used by the public in disabled refuge areas.

Type C outstation is a combination of both types A & B and is designed to be used where the disabled refuge area is within the fire fighting lift lobby of a building.



Type A



Type B



Type C

Description	Part No.	List Price	Usual Delivery
Haescomm type A outstation	HC-OSA	£325.73	Stock
Haescomm type B outstation (back box not supplied, mounts on standard double gang electrical back box, 86mm x 146mm)	HC-OSB	£218.88	Stock
Type B outstation with integrated induction loop	HC-ILB	£482.27	1 Week
Haescomm type C outstation	HC-OSC	£550.37	1 Week
Recessing bezel for Type A & C outstations	HC-OBZ	£29.68	1 Week
Haescomm IP65 type A outstation	HC-IPA	£432.81	1 Week
Haescomm IP64 type B outstation	HC-IPB2	£460.51	1 Week

INTEGRATED ASSIST CALL (FOR USE WITH HAESCOMM CONTROLLERS)

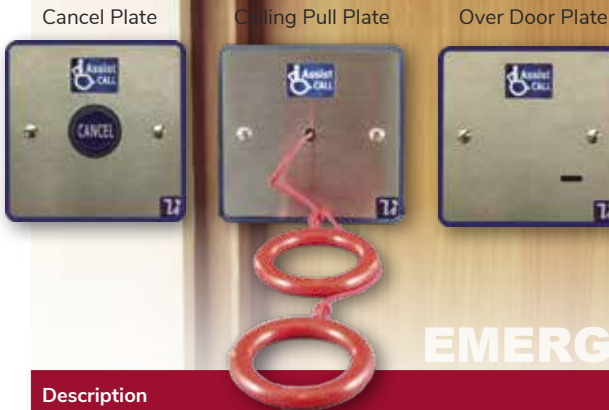

The Assist Call emergency assistance alarm system can be integrated into any Haescomm controller to allow users of the disabled facilities to call for help should they need it.

The integrated Assist Call is designed to provide a fully compliant solution to building owners with many unique benefits, including clear indication, and high quality stainless steel finishes.

Description	Part No.	List Price	Usual Delivery
Haescomm integrated assist call alarm WC system kit 1 x HC-ODP (over door plate) 1 x HC-CNP(cancel plate) 1 x HC-CPP (pull cord) 1 x WC sticker	HC-ACA	£204.04	Stock
Haescomm integrated assist call alarm bedroom system kit 1 x HC-ODP (over door plate) for the corridor 2 x HC-CNP (cancel plate) 1 for the bedside, 1 for the bathroom 3 x HC-CPP (pull cord) 1 for the bedside, 1 beside the toilet and 1 beside the bath or shower 1 x WC sticker	HC-ACB	£406.85	1 Week

INTEGRATED ASSIST CALL TOUCH SCREEN MASTER STATION

The Assist Call touch screen master station with built in network and integral 8 lines for connection to Assist Call systems. Same 4.3" high contrast full colour touch screen as the HC-TMS but without the integrated telephone handset.

- ✓ Accepts assist calls on a shared network
- ✓ 4.3" full colour touch screen
- ✓ Inbuilt networking



Description	Part No.	List Price	Usual Delivery
Haescomm integrated assist call alarm touch screen master station	HC-ACM-8	£1360.26	1 Week

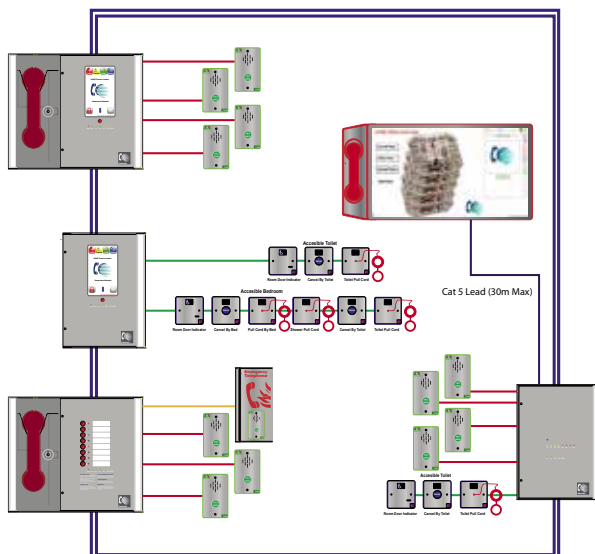

- Cable Key**
- 1 off 2 Core 1.5mm CSA Standard Rated Fire Cable
 - 1 off 2 Core 1.5mm CSA Enhanced Rated Fire Cable
 - 1 off 2 Core 1mm CSA Standard PVC Minimum
 - Network 2 off 2 core 1.5mm CSA Standard fire rated unless Type A or type C outstations are used, then it must be enhanced

Fully integrated Fire Telephone, Disabled Refuge & Emergency Assist in a single solution

SELF CONTAINED ASSIST CALL KITS

Assist Call self contained kits include all the components to provide a stand alone disabled toilet alarm.



The standard kit is for use where the toilet is in a permanently staffed area whereas the remote kit is for remote toilets and includes a 1 zone controller for installation in the staffed area.



Description	Part No.	List Price	Usual Delivery
Assist Call self contained standard kit 1 x HC-PSC (PSU/over door plate) 1 x HC-CNP (cancel plate) 1 x HC-CPP (pull cord) 1 x WC sticker	HC-STK	£262.16	1 Week
Assist Call self contained remote kit 1 x HC-1ZC (1 zone controller PSU with accept) 1 x HC-ODP (over door plate) 1 x HC-CNP (cancel plate) 1 x HC-CPP (pull cord) 1 x WC sticker	HC-RTK	£367.28	1 Week

ASSIST CALL REMOTE CONTROLLERS

Description	Part No.	List Price	Usual Delivery
Assist Call 1 zone controller with combined PSU	HC-1ZC	£164.47	1 Week
Assist Call 4 zone controller. Requires HC-PSU power supply	HC-4ZC	£234.95	1 Week
Assist Call power supply for use with HC-4ZC	HC-PSU	£185.49	1 Week
Assist Call battery backup for HC-PSU	HC-BAT-2	£130.29	1 Week

ASSIST CALL INDIVIDUAL PARTS

Description	Part No.	List Price	Usual Delivery
Assist Call over door plate	HC-ODP	£70.49	Stock
Assist Call cancel plate	HC-CNP	£76.67	Stock
Assist Call pull cord plate	HC-CPP	£66.78	Stock
Assist Call call plate	HC-CLP	£76.67	1 Week
Assist Call power supply with integrated over door indicator	HC-PSC	£130.29	1 Week
Assist Call switch interface plate	HC-SIP	£79.14	1 Week
Assist Call 600mAH NIMH rechargeable battery pack for HC-PSC	HC-BAT	£56.88	1 Week
Assist Call single gang brushed stainless steel pattress cover for surface back boxes	HC-SSP	£21.03	1 Week

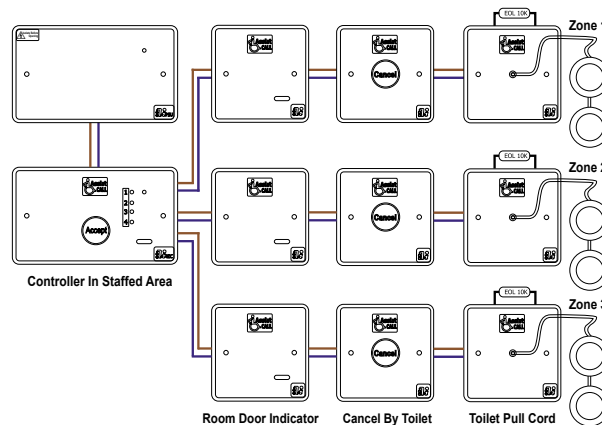



QUANTEC ADDRESSABLE CALL SYSTEM



Quantec

An addressable call system, ideal for use in care homes, hospitals, GP surgeries, hotels and leisure centres.

- ✓ Up to 7 call levels - standard, en-suite, help required, emergency attack, presence & attendance
- ✓ Up to 256 monitored, addressable devices per system
- ✓ Flexible call routing - allows system to be tailored to suit a site's exact operational needs
- ✓ Extensive range of system components
- ✓ Optional surveyor data management software

Quantec Controllers

Description	Part No.	List Price	Usual Delivery
Quantec controller, one required per system, space for 2 x 7Ah batteries	QT601-2	£552.52	1 Week
Quantec corridor display unit with controls	QT608C	£253.36	1 Week
Quantec network splitter	QT603	£34.76	1 Week
Quantec programming software & upload/download lead	QT707	£136.03	1 Week

Quantec System Accessories

Please contact our sales department for full range of accessories

Description	Part No.	List Price	Usual Delivery
Quantec call point & remote socket, button reset	QT602	£62.05	1 Week
Tail call button, 6ft	NC805C-6	£17.72	1 Week
Quantec slave ceiling pull unit	QT607	£27.18	1 Week
Quantec slave over door light	QT606	£71.37	1 Week
Quantec addressable over door light c/w sounder	QT606A	£71.41	1 Week

800 SERIES CONVENTIONAL CALL SYSTEM

Conventional call system, ideal for use in care homes, hospitals, GP surgeries, hotels and leisure centres.

- ✓ Indicator panels from 1 to 20 zones
- ✓ 12vdc system, simple to install & operate - std 6 core security cable ideal for most installations
- ✓ Two levels of call, standard & emergency
- ✓ Extensive range of system accessories

800 SERIES



800 Series Controllers

Description	Part No.	List Price	Usual Delivery
10 zone call controller c/w on board 12v 300mA PSU. Flush mount	NC910F	£286.13	1 Week
20 zone call controller c/w on board 12v 300mA PSU. Flush mount	NC920F	£389.13	1 Week

800 Series System Accessories

Please contact our sales department for full range of accessories

Description	Part No.	List Price	Usual Delivery
Standard call point, button reset & remote socket	NC802DB	£34.34	1 Week
Emergency call point, button reset & remote socket	NC802DEB-1-2	£62.95	1 Week
Ceiling pull cord (no reset)	NC807C	£27.49	1 Week
Button reset point	NC809DB	£16.01	1 Week
Over door light	NC806C	£27.49	1 Week
Over door light with sounder	NC806CS	£42.36	1 Week

SIGTEL EMERGENCY VOICE COMMUNICATION SYSTEM

For disabled refuge & fire telephone applications. Ideal for hotels, shopping malls, office blocks, sports stadiums etc.

- ✓ Compact 4 or 8 line controllers
- ✓ Network card allows interlinking of up to four controllers
- ✓ Unique auto-learn facility allow fast network setup
- ✓ Exceeds the requirements of BS 5839 Pt 9

Sigtel System Controllers

Description	Part No.	List Price	Usual Delivery
4 line master EVC controller c/w handset & display, requires 2 x 7Ah batts	ECU-4	£1226.99	1 Week
8 line master EVC controller c/w handset & display, requires 2 x 7Ah batts	ECU-8	£1566.22	1 Week
8 line master EVC controller, no handset, requires 2 x 7Ah batts	ECU-8NT	£1206.67	1 Week
Network card (allows up to four ECU-4/8 to be interlinked)	ECU722	£151.58	1 Week
PC configuration software & mini USB download lead	EVC423	£174.91	1 Week

Sigtel Outstations (Type B)

Please contact our sales department for full range of outstations

Description	Part No.	List Price	Usual Delivery
Green hands free EVC outstation, flush mounting	EVC302GF	£228.66	1 Week
Green hands free EVC outstation, surface mounting	EVC302GS	£243.67	1 Week
Stainless steel hands free EVC outstation, flush mounting	EVC302F	£254.06	1 Week
Stainless steel hands free EVC outstation, surface mounting	EVC302S	£270.74	1 Week
Weatherproof enclosure, IP66, steel, non locking (for use with flush units)	BF359-1	£200.02	1 Week

DISABLED TOILET ALARM

- ✓ Available in standard & stainless steel finish
- ✓ Kit includes: call controller c/w onboard backup facility, ceiling pull cord, over door light c/w sounder, reset point c/w sounder & Disabled WC sticker
- ✓ Kits can be integrated into 800 series conventional call system

Disabled Toilet Alarm Kits

Description	Part No.	List Price	Usual Delivery
Standard finish disabled persons toilet alarm kit	NC951	£159.83	Stock
Stainless steel disabled persons toilet alarm kit	NC951-SS	£240.13	1 Week

VIBRATING PILLOW ALARM

Description	Part No	List Price	Usual Delivery
24v vibrating pad c/w jack plug	BF320	£75.79	1 Week
Single gang locking jack socket	BF320JP	£62.54	1 Week



HEARING LOOP SYSTEM KITS



C-TEC's best-selling PDA range of hearing loop equipment includes the UK's widest range of induction loop amplifiers, microphones, connector plates and test equipment.

Designed to allow hearing aid users to participate more fully in general conversation and other activities, the range includes a variety of cost-effective kits for use in ticket offices, churches, meeting rooms, lecture theatres, GP surgeries and more – all exceeding the requirements of current British Standards when correctly installed.

1.2m² Portable HearingLoop Kit

Description	Part No	List Price	Usual Delivery
Portable hearing loop kit	PL1-K3	£304.20	1 Week
Wall mounting storage shelf for PL1 amplifier	PL1-SHELF	£45.04	1 Week



1.5m² Counter Hearing Loop Amplifier Kit

Description	Part No	List Price	Usual Delivery
Counter hearing loop kit	PDA103C	£197.26	1 Week



50m² Hearing Loop Amplifier Kits

Description	Part No	List Price	Usual Delivery
Domestic loop amplifier kit	DL50-K	£212.41	1 Week
Small room loop kit (tie/desk mic)	PDA103L	£195.73	1 Week
Small room loop kit (omni-directional plated mic)	PDA103R	£232.25	1 Week
TV lounge loop kit	PDA103S	£249.69	1 Week



200m² Hearing Loop Amplifier Kits

Description	Part No	List Price	Usual Delivery
Meeting/seminar room loop kit	AKM1	£348.92	1 Week
Professional lecture room loop kit	AKM3	£940.59	1 Week
Lecture room loop kit	AKL1	£443.82	1 Week
TV/music lounge loop kit	AKT1	£763.89	1 Week
Place of worship loop kit c/w fixed lectern microphone	AKW1	£482.08	1 Week
Place of worship loop kit c/w levalier radio microphone	AKW2-L	£1127.48	1 Week
Health and fitness club loop kit c/w levalier radio microphone	AKH1-L	£1151.04	1 Week

PHASE SHIFTING DUAL HEARING LOOP AMPLIFIER KITS

Description	Part No	List Price	Usual Delivery
4U rack with dual hearing loop amplifiers, for areas up to 200m ²	DLR5	£2280.62	1 Week
4U rack with dual Hearing loop amplifiers, for areas up to 500m ²	DLR7	£2557.30	1 Week



PDA RANGE OUTREACH PLATE AUDIO INPUT EXTENSION SYSTEM

Description	Part No	List Price	Usual Delivery
3.5mm mono jack plate (takes AMT, AMH, AML or AMD mics)	APJ	£53.63	1 Week
Line level audio plate (takes APS SCART lead/other line level audio feeds)	APL	£53.63	1 Week
6.35mm stereo jack plate (takes AMR/L & AMR/H radio microphone kit)	APQM	£53.63	1 Week
6.35mm stereo jack plate (takes line level feeds from mixing desks, etc)	APQL	£53.63	1 Week
XLR mic level plate (takes AMP microphone)	APXM	£53.63	1 Week
XLR line level plate (takes line level feeds from mixing desks, etc)	APXL	£53.63	1 Week
Omni-directional plated microphone. Wall, ceiling or desk mountable	APM	£53.63	1 Week
XLR balanced line o/p plate (connects Outreach chain to 3rd-party equipment)	APXO	£82.41	1 Week

PDA RANGE MICROPHONES

Description	Part No	List Price	Usual Delivery
Omni-directional plated microphone. Wall, ceiling or desk mountable	APM	£46.84	1 Week
Tie/desk mic. for ML1, PDA102, PDA200E, PL1, PDA-PRO or APJ plate	AMT	£7.65	1 Week
Lectern mic. for ML1, PDA102, PDA200E, PL1, PDA-PRO or APJ plate	AML	£54.66	1 Week
Lectern mic. (short stemmed version of AML)	AMLS	£54.66	1 Week
Desktop mic. for ML1, PDA102, PDA200E, PL1, PDA-PRO or APJ plate	AMD	£76.52	1 Week
Desktop mic. (short stemmed version of AMD)	AMDS	£76.52	1 Week
Desktop mic. (push to talk)	AMD-P	£213.99	1 Week
Professional handheld mic. for PDA200E or APXM plate, requires AXLR lead	AMP	£310.23	1 Week
Lavalier radio mic. kit c/w receiver, transmitter, PSU for PDA200E or APQM outreach plate	AMR-LA	£536.15	1 Week
Handheld radio mic. c/w receiver, transmitter, PSU for PDA200E or APQM outreach plate	AMR-HA	£562.96	1 Week
Hanging ambient mic. for PDA-PRO Range or APXM plate	PRO45	£386.23	1 Week

HEARING LOOP CABLE

Description	Part No	List Price	Usual Delivery
100m x 1.0mm2 single core white loop cable	LOOP2-W	£112.20	1 Week
100m x 1.5mm2 single core white loop cable	LOOP3-W	£80.40	1 Week
100m x 1.0 mm2 insulated copper tape (flat loop cable for under carpets)	FLAT2005	£204.50	1 Week
100m x 1.5mm2 insulated copper tape (flat loop cable for under carpets)	FLAT3005	£230.05	1 Week
50m printed hearing loop foil loop tape	TAPE-P	£52.13	1 Week

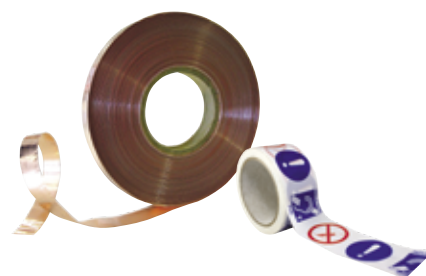
HEARING LOOP TEST EQUIPMENT

Description	Part No	List Price	Usual Delivery
FosMeter-Pro Hearing Loop Test Kit (c/w Tester, Signal Generator & headphones)	FPROK1	£703.59	1 Week



CONVENTIONAL DETECTORS - SERIES 65

Detectors

Description	Part No	List Price	Usual Delivery
Optical smoke detector	55000-317	£29.63	Stock
A1R combined heat detector, 57oC	55000-122	£18.82	Stock
BR combined heat detector, 75oC	55000-127	£19.76	Stock
CR combined heat detector, 90oC	55000-132	£20.23	Stock
CS fixed temperature heat detector, 90oC	55000-137	£19.50	Stock
UV flame detector, base mounted	55000-025	£513.03	3 Working Days

series65



Bases

Description	Part No	List Price	Usual Delivery
Detector base with schottky diode	45681-201	£4.70	Stock
Twin Wire detector base	45681-206	£14.74	Stock
Standard detector base	45681-200	£4.45	Stock
Detector base with 24v relay	45681-245	£28.45	3 Working Days
Detector base with 12v relay	45681-508	£11.86	3 Working Days



TW

CONVENTIONAL DETECTORS - ORBIS

Description	Part No	List Price	Usual Delivery
Optical smoke detector	ORB-OP-12001	£29.63	Stock
Multi sensor detector	ORB-OH-13001	£31.04	Stock
A1R combined heat detector, 57oC	ORB-HT-11001	£19.66	Stock
A2S fixed temperature heat detector, 57oC	ORB-HT-11002	£19.53	3 Working Days
BS fixed temperature heat detector, 75oC	ORB-HT-11004	£20.80	3 Working Days
Time Saver base with schottky diode	ORB-DB-00003	£4.94	Stock
Twin Wire Time Saver base	ORB-SW-10005	£14.52	Stock
Time Saver standard base	ORB-MB-00001	£5.67	3 Working Days
Time Saver base without continuity switch	ORB-MB-00002	£5.32	Stock
Time Saver relay base	ORB-RB-10004	£23.79	3 Working Days

orbis®



TW

REMOTE INDICATOR LAMPS

Remote Indicator LEDs

Description	Part No	List Price	Usual Delivery
MiniDisc remote indicator	53832-070	£6.99	Stock
'Detector Activated' remote indicator (flush)	RIL58	£6.21	Stock
Back box for RIL58 remote indicator	RILBOX	£2.05	Stock
Multi purpose indicator LED, 3-16vdc or 5-30vdc	REM-C	£10.09	Stock
Multi purpose LED & buzzer, 3-16vdc or 5-30vdc	REM-C-B	£17.00	Stock



ANALOGUE ADDRESSABLE DETECTORS - XP95
Detectors

Description	Part No	List Price	Usual Delivery
Optical smoke detector	55000-600	£57.05	Stock
Multisensor	55000-885	£63.19	Stock
Heat sensor	55000-400	£57.05	Stock
High temperature heat sensor	55000-401	£57.05	Stock
Intelligent UV flame detector	55000-022	£602.86	3 Working Days
Intelligent IR3 flame detector	55000-024	£1055.62	3 Working Days

ANALOGUE ADDRESSABLE DETECTORS - DISCOVERY
Detectors

Description	Part No	List Price	Usual Delivery
Optical smoke detector	58000-600	£60.97	Stock
Multisensor	58000-700	£65.99	Stock
CO detector	58000-300	£82.52	3 Working Days
Heat sensor	58000-400	£60.97	Stock

INTELLIGENT MANUAL CALL POINTS

Description	Part No	List Price	Usual Delivery
Intelligent manual call point, red	SA5900-908	£47.97	Stock
Intelligent manual call point, red, waterproof	58200-951	£152.43	Stock
Hinged transparent cover	44251-189	£3.14	Stock
Pack of 10 spare reset keys	44251-176	£9.25	Stock

BASES & ACCESSORIES

Description	Part No	List Price	Usual Delivery
Detector base c/w Xpert address card	45681-210	£4.70	Stock
Spare Xpert address card (pack of 25)	45682-800	£9.75	Stock
Detector base with short circuit isolator	45681-284	£15.36	Stock
Stand alone short circuit isolator	55000-720	£25.48	Stock
Base for stand alone short circuit isolator	45681-211	£4.45	Stock
Low power relay base	45681-242	£26.40	3 Working Days



Description	Part No	List Price	Usual Delivery
Apollo analogue addressable test set	SA7800-870	£1079.14	3 Working Days

NEW

ANALOGUE ADDRESSABLE DETECTORS - SOTERIA

SOTERIA[®]
DETECTION > DEFINED



New Apollo Soteria detectors now available to order.

Description	Part No	List Price	Usual Delivery
Soteria optical smoke detector with isolator	SA5100-600	£67.15	3 Working Days
Soteria heat detector with isolator	SA5100-400	£67.15	3 Working Days
Soteria optical/heat multi-sensor with isolator	SA5100-700	£76.78	3 Working Days
Soteria optical smoke detector without isolator	SA5000-600	£64.09	3 Working Days
Soteria heat detector without isolator	SA5000-400	£64.09	3 Working Days
Soteria optical/heat multi-sensor without isolator	SA5000-700	£76.78	3 Working Days
Soteria XPERT 8 intelligent mounting base	SA5000-200	£4.32	3 Working Days

NEW SOTERIA DIMENSION FLAT ANALOGUE ADDRESSABLE DETECTORS

SOTERIA[®]
DIMENSION

SOTERIA[®] Dimension is a range of sleek, flat optical fire detectors for flush mounting, using chamberless fire detection technology. The new range consists of an Optical Detector designed for commercial environments with high aesthetic requirements and a Specialist Optical Detector, designed for custodial and care environments. Both detectors are flush mounted with a Mounting Box.



Description	Part No	List Price	Usual Delivery
Soteria Dimension optical detector	FL5100-600	£323.74	3 Working Days
Soteria Dimension specialist optical detector	FL6100-600	£586.08	3 Working Days
Soteria Dimension mounting box	FL5000-200	£16.21	3 Working Days

INTERFACES

Intelligent Interfaces

Description	Part No	List Price	Usual Delivery
Mains switching input/output unit	SA4700-103	£102.64	Stock
Intelligent input/output unit	SA4700-102	£87.13	Stock
Dual input/output unit	SA4700-104	£117.34	Stock
Switch monitor unit	SA4700-100	£73.53	Stock
Dual switch monitor unit	SA6700-100	£97.37	Stock
DIN-Rail input/output	SA4700-302	£97.92	Stock
DIN-Rail switch monitor	SA4700-300	£82.11	Stock



DIN Rail Interfaces

Description	Part No	List Price	Usual Delivery
DIN rail sounder control interface (5 amp) XP95	55000-182	£138.40	Stock
DIN rail zone monitor interface with isolator XP95	55000-812	£106.05	Stock



APOLLO DETECTION EQUIPMENT

CoreProtocol[®]

ANALOGUE ADDRESSABLE INTERFACES - XP95
XP95 Interfaces

Description	Part No	List Price	Usual Delivery
Miniature switch monitor	55000-760	£63.71	Stock
Zone monitor	55000-845	£77.12	Stock
Sounder control unit	55000-852	£98.08	Stock
3 Channel input / output interface	55000-588	£149.79	Stock

LOOP POWERED SOUNDERS & VISUAL INDICATORS
Base/Platform Sounders & Visual Indicators

Description	Part No	List Price	Usual Delivery
Loop powered beacon	55000-877	£54.30	Stock
Integrated sounder base with isolator	45681-277	£50.69	Stock
Integrated sounder base	45681-278	£49.36	Stock
Integrated sounder/beacon base with isolator	45681-330	£81.30	Stock
Integrated sounder/beacon base	45681-331	£77.32	Stock
Integrated beacon base with isolator	45681-333	£49.50	Stock
Ancillary sounder base (non addressable)	45681-276	£45.10	Stock
White blanking cover for above units	45681-292	£4.03	Stock
Red blanking cover for above units	45681-293	£4.03	Stock

Intelligent Open-Area Sounders & Visual Indicators (Sonos®)

Description	Part No	List Price	Usual Delivery
Red sounder, IP65, with isolator	55000-001	£62.74	Stock
Sounder/beacon, red lens, IP65, with isolator	55000-005	£94.95	Stock
Beacon, red lens, IP65, with isolator	55000-009	£60.42	Stock

Intelligent Open-Area Sounders & Visual Indicators

Description	Part No	List Price	Usual Delivery
Red sounder	55000-278	£89.47	Stock
Red waterproof sounder, IP66	55000-274	£184.21	Stock
Red sounder/beacon with isolator	55000-293	£130.10	Stock
Red waterproof sndr/beacon, IP66 with isolator	55000-298	£217.02	Stock
Red waterproof sndr/beacon, IP66	55000-296	£219.13	Stock

LOOP POWERED EN54-23 VISUAL ALARM DEVICES
Loop Powered EN54-23 Visual Alarm Devices - XP95

Description	Part No	List Price	Usual Delivery
Integrated sounder/VAD base with isolator, Cat O	45681-705	£139.03	Stock
Integrated VAD base with isolator, Cat O	45681-709	£97.22	Stock
Wall VAD, red body, white flash, W-2.4-6	55000-741	£70.30	Stock
Wall VAD, white body, white flash, W-2.4-6	55000-744	£70.30	3 Working Days

Discovery Protocol Sounder/VID/VAD

Description	Part No	List Price	Usual Delivery
Discovery sounder/beacon base with isolator	45681-393	£84.80	3 Working Days
Discovery open-area sounder/beacon, red	58000-005	£96.48	3 Working Days
Discovery EN54-23 sndr/VAD base with isolator	45681-700	£135.01	3 Working Days
Integrated sounder base with isolator, Discovery	45681-702	£64.39	Stock



Order before 3.00pm for sameday despatch



wireless technology

XPander is a system in which individual detectors, call points and alarm devices communicate with the XP95 loop by radio signals. An interface is connected to the loop in the same way as any other interface, such as an Input/Output Unit.

Every XPander device is assigned an address and this address is recognised by the control panel in the same way as the address of any device connected directly to the loop wiring.

XPander Detectors & Call Point

Description	Part No.	List Price	Usual Delivery
Optical detector with address module, c/w base	XPA-CB-12034	£281.93	Stock
A1R heat detector with address module, c/w base	XPA-CB-11170	£279.53	Stock
CS heat detector with address module, c/w base	XPA-CB-11171	£279.65	3 Working Days
Multisensor detector with address module, c/w base	XPA-CB-13032	£298.47	3 Working Days
Call point (integral address module)	XPA-MC-14006	£265.57	Stock
Spare Xpert address card (white)	29600-413	£1.25	Stock
Xpander remote indicator module	XPA-IN-14102	£290.16	3 Working Days

Detectors also available as spare head only. Please enquire

XPander Sounders & Visual Indicators

Description	Part No.	List Price	Usual Delivery
Red sounder	XPA-CB-14001	£363.41	Stock
White sounder	XPA-CB-14002	£363.41	Stock
Sounder/beacon, red sounder, red lens	XPA-CB-14003	£419.33	3 Working Days
Sounder/beacon, white sounder, amber lens	XPA-CB-14004	£419.52	3 Working Days
Spare Xpert address card (red)	29600-399	£1.25	Stock

XPander Combined Detectors Sounders & Visual Indicators

Description	Part No.	List Price	Usual Delivery
Combined sounder & optical smoke detector	XPA-CB-14016	£536.41	Stock
Combined sounder & A1R heat detector	XPA-CB-14017	£536.41	Stock
Combined sounder & CS heat detector	XPA-CB-14018	£536.65	3 Working Days
Combined sounder/red lens beacon & optical smoke detector	XPA-CB-14020	£556.03	Stock
Combined sounder/red lens beacon & A1R heat detector	XPA-CB-14021	£556.27	3 Working Days
Combined sounder/red lens beacon & CS heat detector	XPA-CB-14022	£556.27	3 Working Days

XPander Interfaces

Description	Part No.	List Price	Usual Delivery
868MHz diversity Loop Interface	XPA-IN-14050	£559.10	Stock
Single channel input/output unit	XPA-IN-14011	£271.00	Stock
Dual channel input/output unit	XPA-IN-14012	£294.63	3 Working Days



Important Note:

As with all radio equipment, a site survey and detailed report must be carried out by a suitably qualified person, prior to any installation. Please contact us for further details.

A range of conventional detection and alarm products specially designed for connection to a single pair of supply wires



AlarmSense®

TWO-WIRE TECHNOLOGY

- ✓ Local & general alarm switching
- ✓ False alarm reduction with "non-priority" signalling
- ✓ RemovAlert™ head removal monitoring
- ✓ SynchroPulse™ technology for alarm synchronisation
- ✓ Quick and simple installation
- ✓ Reduced wiring costs



See page 11 for control panel details



AlarmSense Devices

Description	Part No.	List Price	Usual Delivery
AlarmSense optical smoke detector	55000-390	£27.14	Stock
AlarmSense integrating optical smoke detector	55000-391	£31.01	Stock
AlarmSense A1R heat detector (standard)	55000-190	£17.22	Stock
AlarmSense CS heat detector (high temp)	55000-193	£17.46	Stock
AlarmSense base	45681-244	£5.89	Stock
AlarmSense alarm relay	55000-835	£45.24	Stock
AlarmSense optical smoke detector and sounder base	55000-392	£56.23	Stock
AlarmSense integrating optical detector and sounder base	55000-393	£58.18	Stock
AlarmSense A1R heat detector and sounder base	55000-196	£54.29	Stock
AlarmSense CS heat detector and sounder base	55000-197	£54.31	Stock
AlarmSense optical smoke detector and sndr beacon base	55000-394	£69.15	Stock
AlarmSense integrating optical detector & sounder beacon	55000-395	£72.40	Stock
AlarmSense A1R heat detector and sounder beacon base	55000-198	£64.00	Stock
AlarmSense CS heat detector and sounder beacon base	55000-199	£66.58	Stock
AlarmSense open area sounder - red	55000-018	£54.11	Stock
AlarmSense open area sounder beacon - red	55000-017	£67.03	Stock
AlarmSense sounder base	45681-510	£31.16	Stock
AlarmSense sounder beacon base	45681-509	£45.88	Stock
Locking white cap	45681-294	£3.54	Stock
AlarmSense manual call point	55400-894	£27.79	Stock

APOLLO ACCESSORIES

Duct Detection Kits

Description	Part No	List Price	Usual Delivery
S65 duct kit c/w 360mm tube (diode base)	53546-021	£103.84	3 Working Days
Orbis duct kit c/w 360mm tube (diode base)	53546-023	£104.85	3 Working Days
XP95 duct kit c/w 360mm tube (XP95 base)	53546-022	£104.83	3 Working Days
300 - 750mm duct sampling tube	53541-170	£14.82	3 Working Days
750 - 1500mm duct sampling tube	53541-171	£29.67	3 Working Days



Mounting Accessories

Description	Part No	List Price	Usual Delivery
Conduit box	45681-204	£5.33	3 Working Days
Deckhead mounting box	45681-217	£19.74	3 Working Days
Deckhead mounting box accessory kit	45681-218	£6.61	3 Working Days
Ceiling tile mounting box for detectors	45681-309	£10.58	3 Working Days
Ceiling tile mounting box for sounders	45681-310	£10.58	3 Working Days



Protective Cages for Detectors

Description	Part No	List Price	Usual Delivery
175mm Di x 75mm D. For flush cabled detector	STI-9604	£33.26	Stock
180mm Di x 115mm D. For surface cabled detector	STI9605	£36.76	Stock



Full range of protective cages
Page 77

C-TEC SOUNDERS & VADS - SUITABLE FOR XP95/DISCOVERY PROTOCOL SYSTEMS



EN54-3 Base Sounders & VADs

Description	Part No	List Price	Usual Delivery
96dB base sounder, white	BF431A-CX-W	£42.15	Stock
C-3-8 base VAD c/w 96dB sounder, white/clear	BF456A-CX-W	£73.78	Stock
C-3-8 base VAD, white/clear	BF460A-CX-W	£50.06	1 Week



EN54-3 High Output Wall Sounders & VADs

Description	Part No	List Price	Usual Delivery
103dB wall sounder, red, deep base	BF430A-CX-DR	£61.70	Stock
W-2.4-8.2 wall VAD c/w 103dB sndr, red, d/base	BF433A-CX-DR	£88.07	Stock
W-2.4-8.2 wall VAD / sndr, red, d/base, IP65	BF433A-CX-DR-65	£105.34	Stock



EN54-3 Compact Ceiling Sounders & VADs

Description	Part No	List Price	Usual Delivery
91dB ceiling sounder, shallow base, white	BF450A-CX-SW	£49.36	1 Week
C-3-8 ceiling VAD c/w 91dB Sndr, s/base, white	BF451A-CX-SW	£70.54	1 Week
C-3-8 ceiling VAD, shallow base, white	BF458A-CX-SW	£63.50	1 Week



Fully compatible with C-Tec XFP-X Range of Analogue Addressable Control Panels

CONVENTIONAL DETECTORS - EVOLUTION

Smoke & Heat Detectors

Description	Part No	List Price	Usual Delivery
Optical smoke detector	EVC-P	£28.89	Stock
A2S fixed temperature heat detector, 62oC	EVC-H-A2S	£24.57	Stock
CS fixed temperature heat detector, 92oC	EVC-H-CS	£24.57	Stock

Bases

Description	Part No	List Price	Usual Delivery
Detector base with schottky diode	UB-4SD	£5.49	Stock
Standard detector base	UB-6-EV	£4.13	Stock



ANALOGUE ADDRESSABLE - NEW EVOLUTION PROTOCOL

Analogue Addressable Detectors & Call Points

Description	Part No	List Price	Usual Delivery
Optical smoke detector	EV-P	£48.16	1 Week
Dual optical detector	EV-DP	£54.90	1 Week
Optical smoke detector with built in sounder	EV-PYS	£86.54	1 Week
A1R heat detector	EV-H-A1R	£48.16	1 Week
CS heat detector	EV-H-CS	£48.16	1 Week
Combined smoke & heat detector	EV-PH	£60.54	1 Week
Standard detector base	UB-6-EV	£3.93	1 Week
Detector base with short circuit isolator	EV-B-SCI	£20.93	1 Week
Evolution address programmer kit	EV-AD2-KIT	£225.37	1 Week
Programming adapter for EV-AV2/SB sndr/beacon	EV-AVADAPT	£40.64	1 Week
Addressable manual call point	EV-MCP2-IP24	£49.91	1 Week
Addressable manual call point with SCI	EV-MCP2-SCI-IP24	£51.58	1 Week
Waterproof addressable manual call point	EV-MCP2-IP67	£171.93	1 Week
Waterproof addressable call point with SCI	EV-MCP2-SCI-IP67	£171.93	1 Week



Analogue Addressable Sounders & Visual Indicators

Description	Part No	List Price	Usual Delivery
Base sounder with integrated detector base	EV-SDR-BASE	£59.39	1 Week
Base sounder/beacon with integrated det base	EV-AV2-BASE	£86.93	1 Week
Low profile sounder	EV-SDR	£59.39	1 Week
Low profile sounder/beacon	EV-AV2	£86.93	1 Week
Beacon base (for use with EV-PS)	EV-PSBCN	£46.68	1 Week
Wall mounted high output sounder	EV-HIOP-SDR-SCI	£103.15	1 Week
Wall mounted high output sounder/beacon	EV-HIOP-SB-SCI	£131.28	1 Week
Wall mounted high output beacon	EV-HIOP-BCN-SCI	£115.66	1 Week



Accessories

Description	Part No	List Price	Usual Delivery
Mini input module	EV-MINI-IP	£80.49	1 Week
Input module	EV-IP	£96.59	1 Week
Output module	EV-OP	£86.93	1 Week
Single input/output module	EV-SIO	£115.91	1 Week
Zone module	EV-ZMU	£125.56	1 Week
Sounder booster module	EV-SBM	£144.69	1 Week
Mains switching relay	EV-240V-MRA	£105.12	1 Week



CONVENTIONAL DETECTORS - CDX RANGE

Smoke & Heat Detectors

	Description	Part No	List Price	Usual Delivery
○	Optical smoke detector	SOC-E3N	£30.66	Stock
○	A1R combined heat detector, 60oC	DCD-AE3	£20.16	Stock
○	CR combined heat detector, 90oC	DCD-CE3	£20.16	Stock
○	A1S fixed temperature heat detector, 60oC	DFJ-AE3	£20.16	Stock
○	CS fixed temperature heat detector, 90oC	DFJ-CE3	£20.16	Stock
○	Waterproof heat detector, 60oC (no base req'd)	DFG-60BLKJ	£77.69	Stock

Available in ivory & white (add suffix -WHT for white)

CDX



Bases

	Description	Part No	List Price	Usual Delivery
○	Detector base with schottky diode	YBN-R-6SK	£4.94	Stock
○	Twin Wire detector base	YBO-R-6PA	£15.02	Stock
○	Standard detector base	YBN-R-6	£3.69	Stock
○	Detector base with latching relay	YBO-R-6R	£15.11	3 Working Days
○	Detector base with non latching relay	YBO-R-6RN	£29.19	3 Working Days

Available in ivory & white (add suffix -WHT for white)



ANALOGUE ADDRESSABLE DETECTORS - ESP RANGE

Smoke & Heat Detectors

	Description	Part No	List Price	Usual Delivery
○	Optical smoke detector	ALN-EN	£56.19	Stock
○	Multisensor	ACC-EN	£61.17	Stock
○	Heat sensor	ATJ-EN	£56.19	Stock
○	IP67 rated waterproof multi-heat detector	ACB-EW	£96.51	3 Working Days

Available in ivory & white (add suffix -WHT for white)

ESP



Bases & Accessories

	Description	Part No	List Price	Usual Delivery
○	Detector base, ivory	YBN-R-3	£3.69	Stock
○	Detector base, white	YBN-R-3-WHT	£3.69	Stock
○	Detector base with short circuit isolator, ivory	YBN-R-3-SCI	£25.03	Stock
○	Detector base with short circuit isolator, white	YBN-R-3-SCI-WHT	£25.03	Stock
○	Blanking cover for YBN-R-3-SCI-WHT	SI-CAP2-WHT	£1.96	Stock



Black Detectors

	Description	Part No	List Price	Usual Delivery
●	Optical smoke detector, black	ALN-EN-BLK	£64.90	3 Working Days
●	Heat detector, black	ATJ-EN-BLK	£65.29	3 Working Days
●	Multi-sensor, black	ACC-EN-BLK	£76.59	3 Working Days
●	Detector base, black	YBN-R-3-BLK	£5.70	3 Working Days



ESP ANALOGUE ADDRESSABLE CALL POINTS

Call Points

Description	Part No	List Price	Usual Delivery
Red call point with isolator (no back box)	HCP-E-SCI	£53.76	3 Working Days
Back box for above call points	MCPBB-R	£1.88	Stock
Waterproof red call point with isolator	HCP-W-SCI	£180.71	3 Working Days

●●●● Other colours available, please enquire



ESP ANALOGUE ADDRESSABLE INTERFACES

Standard Interfaces With Isolator

Description	Part No	List Price	Usual Delivery
Dual input module	CHQ-DIM2-SCI	£70.71	Stock
Dual relay controller module	CHQ-DRC2-SCI	£97.59	Stock
Dual sounder controller module	CHQ-DSC2-SCI	£127.48	Stock
Single zone monitor module	CHQ-SZM2-SCI	£78.42	Stock
Mains relay controller module	CHQ-MRC2-SCI	£81.46	Stock
Plant control module	CHQ-PCM-SCI	£184.94	3 Working Days
Powered output module	CHQ-POM	£44.88	3 Working Days
Single input module	CHQ-SIM	£43.89	3 Working Days
Single output module	CHQ-SOM	£59.89	3 Working Days



DIN-Rail Mounted Interfaces With Isolator

Description	Part No	List Price	Usual Delivery
Dual input module	CHQ-DIM2-DIN-SCI	£83.32	3 Working Days
Dual relay controller module	CHQ-DRC2-DIN-SCI	£100.01	3 Working Days
Dual sounder controller module	CHQ-DSC2-DIN-SCI	£139.72	3 Working Days
Single zone monitor module	CHQ-SZM2-DIN-SCI	£89.18	3 Working Days
Mains relay controller module	CHQ-MRC2-DIN-SCI	£78.92	3 Working Days
Plant control module	CHQ-PCM-DIN-SCI	£210.15	3 Working Days



ANCILLARY EQUIPMENT

Ancillary Equipment

Description	Part No	List Price	Usual Delivery
Hand held address programmer for ESP devices	TCH-B200	£140.65	Stock
Back box for CHQ-OEM modules	CHQ-BACKBOX	£11.52	Stock
Enclosure sub-assembly for CHQ interfaces	CHQ-SUB	£14.12	Stock
Duct probe housing	SDP-3	£223.93	3 Working Days
FIREBEAM beam detector set for ESP loop	ESP-FIREBEAM-XTRA	£752.95	3 Working Days



ESP LOOP POWERED SOUNDERS

Sounders

Description	Part No	List Price	Usual Delivery
○ Base sounder, ivory (req's YBN-R-3 base)	YBO-BS	£55.98	Stock
○ Mounting base, ivory	YBN-R-3	£3.69	Stock
○ Mounting base with short circuit isolator, ivory	YBN-R-3-SCI	£25.03	Stock
○ Blanking cover for base sounders, ivory	SI-CAP2	£1.96	Stock
○ Base sounder, white (req's YBN-R-3-WHT base)	YBO-BS-WHT	£55.98	3 Working Days
○ Mounting base, white	YBN-R-3-WHT	£3.69	Stock
○ Mounting base with short circuit isolator, white	YBN-R-3-SCI-WHT	£25.03	Stock
○ Blanking cover for base sounders, white	SI-CAP2-WHT	£1.96	Stock
● Wall sounder, red (req's YBO-R-3-RED base)	CHQ-WS2	£60.46	Stock
● Mounting base for wall sounders	YBO-R-3-RED	£3.06	Stock
● Mounting base for wall sounders with isolator	YBO-R-SCI-RED	£25.03	3 Working Days
● Weatherproofing kit for wall sounders	CHQ-WPK	£13.23	3 Working Days



ESP EN54-23 VADS

EN54-23 Approved Base Sounder Beacons

Description	Part No	List Price	Usual Delivery
○ Base sounder/beacon, ivory case white LEDs	YBO-BSB2-WL	£80.08	Stock
○ Base sounder/beacon, ivory case red LEDs	YBO-BSB2-RL	£98.17	3 Working Days
○ Mounting base, ivory	YBN-R-3	£3.69	Stock
○ Base sounder/beacon, white case white LEDs	YBO-BSB2-WHT-WL	£80.08	3 Working Days
○ Base sounder/beacon, white case red LEDs	YBO-BSB2-WHT-RL	£98.17	3 Working Days
○ Mounting base, white	YBN-R-3-WHT	£3.69	Stock



EN54-23 Approved Intelligent Wall Sounder Beacons

Description	Part No	List Price	Usual Delivery
● Wall sounder beacon, red case, white LEDs	CHQ-WSB2-WL	£104.10	Stock
● Wall sounder beacon, red case, red LEDs	CHQ-WSB2-RL	£121.99	Stock
● Mounting base for wall sounders, red	YBO-R-3-RED	£3.06	Stock



White body sounders also available, please enquire

EN54-23 Approved Intelligent Ceiling Beacons

Description	Part No	List Price	Usual Delivery
○ Ceiling beacon, ivory case, white LEDs	CHQ-CB-WL	£97.59	3 Working Days
○ Ceiling beacon, ivory case, red LEDs	CHQ-CB-RL	£97.59	3 Working Days
○ Mounting base, ivory	YBN-R-3	£3.69	Stock
○ Ceiling beacon, white case, white LEDs	CHQ-CB-WHT-WL	£97.59	3 Working Days
○ Ceiling beacon, white case, red LEDs	CHQ-CB-WHT-RL	£97.59	3 Working Days
○ Mounting base, white	YBN-R-3-WHT	£3.69	Stock



Red body beacons also available, please enquire

EN54-23 Approved Intelligent Wall Beacons

Description	Part No	List Price	Usual Delivery
● Wall beacon, red case, white LEDs	CHQ-WB-RED-WL	£97.59	3 Working Days
● Wall beacon, red case, red LEDs	CHQ-WB-RED-RL	£97.59	3 Working Days
● Mounting base for wall sounders, white	YBO-R-3-RED	£3.06	Stock
○ Wall beacon, white case, white LEDs	CHQ-WB-WHT-WL	£97.59	3 Working Days
○ Wall beacon, white case, red LEDs	CHQ-WB-WHT-RL	£97.59	3 Working Days
○ Mounting base for wall sounders, white	YBO-R-3-WHT	£3.06	Stock



ARGUS CONVENTIONAL DEVICES

Detectors

Description	Part No	List Price	Usual Delivery
Optical smoke detector	S1000	£24.56	1 Week
Multi-sensor detector	S2000	£29.60	1 Week
Fixed temperature heat detector	S3500-A1R	£17.01	1 Week
Rate of rise heat detector	S3500-B	£17.01	1 Week
Standard detector base	DBS100	£5.15	1 Week



Audio Visual

Description	Part No	List Price	Usual Delivery
Conventional wall sounder, red	CWS100	£41.57	1 Week
Conventional wall sounder VAD, red	CWS100-AV	£74.32	1 Week



Please Note: Minimum order quantities apply, please enquire

ARGUS INTELLIGENT DEVICES - ALTAIR

Detectors

Description	Part No	List Price	Usual Delivery
Optical smoke detector	A1000	£44.09	1 Week
Multi-sensor detector	A2000	£50.06	1 Week
Heat detector	A3500	£44.09	1 Week
Altair detector base	LAB1000	£3.53	1 Week



Programmer

Description	Part No	List Price	Usual Delivery
Altair programming unit	ALPU1000	£184.58	1 Week



Audio Visual

Description	Part No	List Price	Usual Delivery
Intelligent loop powered base sounder	ALBLS100-32	£64.87	1 Week
Intelligent loop powered base sounder/beacon	ALBLS100-32-AV	£99.19	1 Week
Base sounder (slave)	ALBS100-32	£37.16	1 Week
Base sounder/beacon (slave)	ALBS100-32-AV	£82.78	1 Week
Intelligent module for CWS100 & CWS100-AV	ALWS-MOD	£37.79	1 Week



Modules

Description	Part No	List Price	Usual Delivery
Conventional zone module	VMCZ100	£89.43	1 Week
4 input & 4 relay output module	VMIC404	£119.02	1 Week
Single supervised output module plate	VMC100	£55.10	1 Week
Single supervised input module plate	VM100	£51.65	1 Week
Mains rated relay module	VM240	£89.43	1 Week



Intelligent Call Points

Description	Part No	List Price	Usual Delivery
Intelligent resettable call point	ALCP100	£50.08	1 Week
Intelligent waterproof resettable call point	AI-CPW-R-01	£144.40	1 Week
Protective call point cover	ALCI	£5.72	1 Week



Please Note: Minimum order quantities apply, please enquire

FIREBEAM XTRA BEAM DETECTORS

the industry's favourite beam detector is now the world's **longest reaching reflective beam** meaning less beams and less expense.

the firebeam™
protectionsystemXtra

how far do you want to go?

70 metre range
the standard firebeamXtra uses one reflector and will cover up to 70 metres

140 metre range
add the 70KIT140 to the firebeamXtra and cover distances between 70 and 140 metres

160 metre range
add the 140KIT160 to the firebeamXtra and cover distances between 140 and 160 metres

the firebeam™
protectionsystemXtra

Firebeam Xtra Beam Detector - Infra Red - Self Aligning

Description	Part No.	List Price	Usual Delivery
Reflective Firebeam set, 5 - 70M	TFBC-FIREBEAMXTRA	£508.99	Stock
70 - 140M reflector extension kit	TFBC-70KIT140	£81.75	Stock
140 - 160M reflector extension kit	TFBC-140KIT160	£218.00	Stock
Unistrut bracket	TFBC-ADAPTOR	£52.32	Stock
Anti fog reflector & lens window kit	TFBC-FOGKIT	£96.38	Stock
Anti fog reflector	TFBC-REF-AF	£42.43	1 Week
Anti fog window	TFBC-WINDOW-AF	£63.63	1 Week
70 - 140M anti fog reflector extension kit	TFBC-70KIT140-AF	£170.72	1 Week
140 - 160M anti fog reflector extension kit	TFBC-140KIT160-AF	£360.51	1 Week
Universal wall bracket for heads & reflectors	TFBC-FB-BRACKET	£119.90	1 Week

OSID BEAM DETECTORS

OSID by xtralis™ Open-area Smoke Imaging Detection

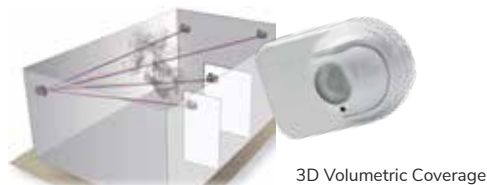

Open-area Smoke Imaging Detection (OSID) by Xtralis is a new innovation in beam smoke detection technology.

Advanced optical imaging technology provides a low cost, reliable and easy-to-install solution that overcomes typical beam detection issues such as alignment difficulties.

Firebeam Beam Detector - Infra Red - Self Aligning

Description	Part No.	List Price	Usual Delivery
Imager, 7° coverage, 24vdc	OSI-10	£827.69	1 Week
Imager, 80° coverage, 24vdc	OSI-90	£854.31	1 Week
Emitter, standard power, battery version	OSE-SP-01	£401.49	1 Week
Emitter, standard power, 24vdc	OSE-SPW	£401.49	1 Week
Emitter, high power, 24vdc	OSE-HPW	£661.62	1 Week
Installation kit (includes: laser alignment tool, test filter & FTDI PC cable)	OSID-INST	£232.13	1 Week
Protective cage	OSID-WG	£64.70	1 Week

FIRERAY BEAM DETECTORS

Why Choose Fireray?

With over half a million units installed worldwide, Fireray® is the first choice for installers and engineers looking for Optical Beam Smoke Detection. Light cancellation, auto aligning and anti condensation technologies makes Fireray® the worlds most trusted beam.



Fireray One - Auto Aligning Reflective Infra-Red Beam Smoke Detector

Description	Part No	List Price	Usual Delivery
Fireray One beam detector set - 50m	BDIR6010-100	£478.25	Stock
Reflective long range kit - 120m	BDIR1010-000	£128.47	Stock



Fireray 5000 - Auto Aligning Reflective Infra-Red Beam Smoke Detector

Description	Part No	List Price	Usual Delivery
Fireray 5000 beam detector set, single prism (50m)	BDIR5000-101	£578.76	Stock
Fireray 5000 beam detector set, 4 prisms (100m)	BDIR5000-102	£704.34	Stock
Additional detector head with 1 prism (50m)	BDIR5000-002	£436.01	Stock
Additional detector head with 4 prisms (100m)	BDIR5000-039	£562.38	1 Week
Long range 3 prism kit to give 100m capability	BDIR5000-004	£130.49	1 Week



Fireray 3000 - End to End Infra-Red Beam Smoke Detector

Description	Part No	List Price	Usual Delivery
Fireray 3000 beam detector set, 5 - 120 m	BDIR3000	£790.72	1 Week
Additional transmitter & receiver head set	BDIR3000-015	£656.80	1 Week



Fireray 3000 Exd - Explosion Proof End to End Beam Smoke Detector

Description	Part No	List Price	Usual Delivery
Explosion proof Fireray 3000 detector set	BDIR3000-115	£3528.00	1 Week
Additional Exd transmitter & receiver head set	BDIR3000-026	£3087.00	1 Week



Fireray Accessories

Description	Part No	List Price	Usual Delivery
Fireray 5000 universal mounting bracket	BDIR5000-005	£138.82	1 Week
Fireray 5000 adjustment bracket	BDIR5000-201	£144.06	1 Week
Fireray 3000 adjustment bracket	BDIR3000-201	£121.16	1 week
4 prism plate for use with 5000-005 or 3000-201	BDIR5000-007	£80.54	1 Week
Reflective prism	BDIR23901-01	£47.83	1 Week
Obscuration test filter	BDIR0209-02	£7.35	1 Week



VESDA ASPIRATING SMOKE DETECTION

The worlds No. 1 brand of Aspirating Smoke Detector

VESDA by Xtralis very early warning smoke detectors provide the earliest warning of a potential fire.

- ✓ Telecommunications facilities
- ✓ Server rooms
- ✓ Financial data centers
- ✓ Clean rooms

VESDA-E VEA ADDRESSABLE ASPIRATING SMOKE DETECTORS



The VESDA-E VEA series of detectors combine VESDA reliability and early warning smoke detection with pinpoint addressability and a variety of annunciation options that truly surpass traditional spot detectors. They use patented air sampling points and multi-channel microbore air-sampling.

As a multi-channel addressable system, the VEA detector is able to divide a protected space into sampling locations, enabling the localization of potential sources of fire for faster incident response.

Please contact our sales team for more details



VESDA-E VEU ASPIRATING SMOKE DETECTORS



The VEU aspirating smoke detectors are the premium detector of the VESDA-E range. An ultra wide sensitivity range, 15 times greater than VESDA VLP, and provision for more sampling holes provide an increased coverage in high airflow applications by at least 40%.

VESDA VEU Detectors

Description	Part No	List Price	Usual Delivery
VESDA VEU with LEDs	VEU-A00	£5374.83	1 Week
VESDA VEU with 3.5" display	VEU-A10	£6188.67	1 Week



VESDA-E VEP ASPIRATING SMOKE DETECTORS



The VESDA-E VEP series of smoke detectors bring the latest and most advanced detection technology to provide very early warning and the best nuisance alarm rejection to a wide range of applications.

VESDA VEP Detectors

Description	Part No	List Price	Usual Delivery
VESDA-E VEP with LEDs, 1 pipe	VEP-A00-1P	£2845.24	1 Week
VESDA-E VEP with LEDs, 4 pipe	VEP-A00-P	£3641.92	1 Week
VESDA-E VEP with 3.5" display, 4 pipe	VEP-A10-P	£4173.40	1 Week



VESDA ASPIRATING SMOKE DETECTION
VESDA VLF Detectors

Description	Part No	List Price	Usual Delivery
VESDA LaserFOCUS 250 (up to 2,500 sq feet)	VLF-250	£1697.48	Stock
VESDA LaserFOCUS 500 (up to 5,000 sq feet)	VLF-500	£2256.86	Stock

VESDA Power Supply Units

Description	Part No	List Price	Usual Delivery
VESDA power supply 24vdc 1A	VPS-215	£309.00	1 Week
VESDA power supply 24vdc 2A	VPS-220	£391.40	1 Week
VESDA power supply 24vdc 5A	VPS-250	£665.30	1 Week
VESDA-E STX power supply 0.5A 14Ah - black	VPS-220-STX	£441.25	1 Week
VESDA-E STX power supply 2A 24Ah - black	VPS-250-STX	£634.48	1 Week
VESDA-E STX power supply 0.5A 14Ah - silver	VPS-220-STX-SLV	£475.86	1 Week
VESDA-E STX power supply 2A 24AH - silver	VPS-250-STX-SLV	£669.09	1 Week

VESDA Spares

Description	Part No	List Price	Usual Delivery
VESDA detector filter cartridge	VSP-005	£103.29	Stock
VESDA detector filter cartridge (pack of 20)	VSP-025	£1684.94	1 Week

VESDA ASPIRATING SYSTEM PIPEWORK 25MM
Red Pipework

Description	Part No	List Price	Usual Delivery
Red ABS 25mm sampling pipe - 3m lengths	REDCLI0250	£6.44	3 Working Days
Red ABS 25mm socket	REDMAI0250	£0.52	3 Working Days
Red ABS 25mm union	REDBOI0250	£2.92	3 Working Days
Red ABS 25mm 90° bend	REDCUI0250	£2.87	3 Working Days
Red ABS 25mm 45° elbow	REDGYI0250	£0.71	3 Working Days
Red ABS 25mm 90° elbow	REDGOI0250	£1.01	3 Working Days
Red ABS 25mm end cap	REDCAI0250	£0.84	3 Working Days
Red ABS 25mm equal tee	REDTII0250	£0.82	3 Working Days
Red 25mm pipe clip	REDPCR0250	£0.79	3 Working Days
ABS solvent cement 250ml	ACCREM0250	£13.07	3 Working Days
25mm red capillary kit with flush air sample point	REDCKI025F	£12.99	3 Working Days
Sampling point label (roll of 100)	REDLAB001	£12.40	3 Working Days

White Pipework

Description	Part No	List Price	Usual Delivery
White ABS 25mm sampling pipe - 3m lengths	WHTCLI0250	£5.08	3 Working Days
White ABS 25mm socket	WHTMAI0250	£0.49	3 Working Days
White ABS 25mm union	WHTBOI0250	£3.22	3 Working Days
White ABS 25mm 90° bend	WHTCUI0250	£2.91	3 Working Days
White ABS 25mm 45° elbow	WHTGYI0250	£0.74	3 Working Days
White ABS 25mm 90° elbow	WHTGOI0250	£0.96	3 Working Days
White ABS 25mm end cap	WHTCAI0250	£0.84	3 Working Days
White ABS 25mm equal tee	WHTTII0250	£0.91	3 Working Days
White 25mm pipe clip	WHTPCR0250	£0.90	3 Working Days

AIRSENSE STRATOS ASPIRATING SMOKE DETECTION

AirSense Stratos is a highly sophisticated high sensitivity aspirated smoke detection product that has been designed to ensure installation and commissioning is as simple as possible. Stratos detectors incorporate a patented 'artificial intelligence' known as ClassiFire™, which ensures a consistent level of protection in virtually any environment.

STRATOS MICRA ASPIRATING SMOKE DETECTORS
Stratos Micra Detectors

Description	Part No	List Price	Usual Delivery
Stratos Micra 25 detector	AS-30671	£1623.44	1 Week
Stratos Micra 25 detector c/w relay input card	AS-30760	£1793.56	1 Week
Stratos Micra 100 detector	AS-30672	£2211.40	1 Week
Stratos Micra 100 detector c/w relay input card	AS-30764	£2381.50	1 Week
Stratos Micra replacement filter	AS-30755	£29.77	Stock

STRATOS HSSD 2 ASPIRATING SMOKE DETECTORS
Stratos HSSD 2 Detectors

Description	Part No	List Price	Usual Delivery
Stratos HSSD 2 detector - ABS enclosure	AS-30621	£3098.26	1 Week
Stratos HSSD 2 detector with Command Module - ABS enclosure	AS-30620	£4574.73	1 Week
Stratos HSSD 2 detector - Steel enclosure	AS-30706	£3023.96	1 Week
Stratos HSSD 2 detector with Command Module - Steel enclosure	AS-30707	£4498.75	1 Week
Stratos HSSD 2 replacement filter	AS-30699	£37.54	Stock

STRATOS ASPIRATING SYSTEM PIPEWORK 3/4" (27MM)

Description	Part No	List Price	Usual Delivery
Red ABS 3/4" sampling pipe - 3m lengths	REDCLE0250	£4.86	3 Working Days
Red ABS 3/4" socket	REDMAP0250	£0.46	3 Working Days
Red ABS 3/4" union	REDBOP0250	£2.51	3 Working Days
Red ABS 3/4" 90° bend	REDCUP0250	£2.59	3 Working Days
Red ABS 3/4" 45° elbow	REDGYP0250	£0.60	3 Working Days
Red ABS 3/4" end cap	REDCAP0250	£0.84	3 Working Days
Red ABS 3/4" equal tee	REDTIP0250	£0.76	3 Working Days
ABS solvent cement 250ml	ACCREM0250	£13.07	3 Working Days
3/4" red capillary kit with flush air sample point	REDCKP025F	£12.26	3 Working Days
Sampling point label (roll of 100)	REDLAB001	£13.02	3 Working Days



RESIDENTIAL DETECTORS & ACCESSORIES

When used with the RadioLINK base, detectors can be wirelessly linked to each other or any other RadioLINK accessory, including a locate & silence controller, call point, CO alarm, relay module and flashing strobe with pillow vibrator for the hearing impaired.

3000 Series, Mains Powered With 10yr Lithium Battery Backup

240V MAINS POWERED	10 YEAR RECHARGEABLE LITHIUM BATTERY BACKUP	EASY-FIT BASE	TEST/SILENCE BUTTON	5 YEAR GUARANTEE	RadioLINK COMPATIBLE
------------------------------	---	---------------	---------------------	------------------	----------------------

Description	Part No	List Price	Usual Delivery
Optical alarm	EI-3016	£82.86	Stock
Heat alarm	EI-3014	£86.27	Stock
Multi-alarm (combined optical & heat sensors)	EI-3024	£108.08	Stock
Heat & CO alarm	EI-3028	£142.42	1 Week
CO alarm	EI-3018	£108.82	1 Week
SmartLINK module	EI-3000MRF	£95.08	Stock

140RC Series, Mains Powered With 9v Alkaline Battery Backup

240V MAINS POWERED	9V ALKALINE BATTERY BACK-UP	EASY-FIT BASE	TEST/SILENCE BUTTON	5 YEAR GUARANTEE	RadioLINK COMPATIBLE
------------------------------	-----------------------------	---------------	---------------------	------------------	----------------------

Description	Part No	List Price	Usual Delivery
Optical alarm	EI-146RC	£47.32	Stock
Heat alarm	EI-144RC	£60.55	Stock
RadioLINK base	EI-168RC	£89.00	Stock

RadioLINK Battery Powered Detectors (RadioLINK module built in)

Description	Part No	List Price	Usual Delivery
Optical alarm with 10yr lithium battery	EI-650RF	£163.59	1 Week
Heat alarm with 10yr lithium battery	EI-603RF	£166.62	1 Week

SmartLINK Gateway

Description	Part No	List Price	Usual Delivery
SmartLINK Gateway remote management for RadioLINK and SmartLINK products	EI-1000G	£288.75	1 Week

RadioLINK Accessories

Description	Part No	List Price	Usual Delivery
Fire/CO alarm interface	EI-414	£286.65	1 Week
Relay module, volt free contacts.	EI-428	£111.83	1 Week
Alarm controller (test, locate & silence)	EI-450	£96.90	1 Week
RadioLINK manual call point	EI-407	£66.33	1 Week
Hard wired relay module with battery backup	EI-128RBU	£81.64	1 Week
Strobe light, mains powered, clear lens	SAB300C	£59.33	1 Week
High output sounder, mains powered	YO3	£122.70	1 week



Signaline Linear Detection

SIGNALINE FT LINEAR HEAT DETECTION



Signaline Fixed Temperature Linear Heat Detector (Signaline FT) detects a build up of heat anywhere along its length. When any point along the cable reaches a predetermined temperature an alarm is initiated. Suitable for use in a very wide range of applications.



All Signaline Heat cable priced per metre, minimum order 50 Metres

Signaline Heat Fixed Temperature

Signaline FT is a fixed temperature linear heat detector which triggers an alarm when the cable reaches a predetermined temperature.

Description	Part No	List Price	Usual Delivery
Signaline FT-68 fixed temp. 68°C	CSSIGFT001	£4.54 per metre	Stock
Signaline FT-88 fixed temp. 88°C	CSSIGFT002	£4.54 per metre	Stock
Signaline FT-105 fixed temp. 105°C	CSSIGFT003	£4.54 per metre	Stock
Signaline FT-68-R fixed temp. 68°C resistant Nylon coated	CSSIGFT005	£5.31 per metre	Stock
Signaline FT-105-R fixed temp. 105°C resistant Nylon coated	CSSIGFT007	£5.31 per metre	Stock



Signaline Heat High Temperature

Description	Part No	List Price	Usual Delivery
Signaline FT-185-R fixed temp. 185°C	CSSIGFT004	£7.50 per metre	Stock
Signaline FT-230-X fixed temp. 230°C	CSSIGFT010	£8.67 per metre	Stock

Signaline LocatorPlus

The Signaline LocatorPlus is a dual zone module for monitoring up to two zones of Signaline FT or FT-R Digital Linear Heat Detection Cable.

Description	Part No	List Price	Usual Delivery
Signaline LocatorPlus	CSSIGLP001	£970.20	Stock



Signaline Heat Clips & Extras

Description	Part No	List Price	Usual Delivery
Signaline universal connector box	CSSIGUC001	£54.71	Stock
T Clip (pack of 100)	CCTCLIP001	£78.15	Stock
P Clip 316 stainless steel M6 (pack of 100)	CCPCLIP002	£125.78	Stock
J Clip inc sleeve and cable tie (pack of 100)	CCJCLIP001	£265.70	Stock
A Clip including cable tie (pack of 100)	CCACLIP001	£66.13	Stock
Edge Clip 3-8mm c/w Neoprene sleeve & cable tie (pack of 100)	CCEDGE001	£249.90	Stock
K Clip (pack of 100) use with Signaline HD only	CCKCLIP001	£78.15	Stock



NEW

NEW SIGNALINE FT-EN LINEAR HEAT DETECTION



Introducing Signaline FT-EN - Signaline FT-EN is a revolution for linear heat detection. Approved to EN54 part 28, Signaline FT-EN uses the latest in heat sensitive polymer technology to offer users fast and reliable fire detection.



Signaline LocatorPlus-EN

- 2 x Alarm Zones
- 1000m of Signaline FT-EN cable per zone
- Automatic alarm indication display
- Alarm relay contact

Signaline FT-EN Linear Heat Detector

- 78°C or 88°C alarm temperature
- Low smoke zero Halogen
- UV stable and chemical resistant
- Up to 1000m per zone

Signaline FT-EOL-EN

- Dual zone end of line unit
- Alarm test push button
- Fault alarm switch
- IP66 rated



Signaline FT-EN low smoke zero halogen linear heat detection cables are designed to be UV and corrosive resistant, meaning they can be used in the harshest of environments. The new LocatorPlus-EN monitoring module has two separate zones, each capable of connecting up to 1000 metres of cable. Completing the installation is easy with the Signaline FT-EOL-EN. This end of line monitoring device comes complete with a fault and alarm test switches meaning live heat testing is no longer required.

Description	Part No.	List Price	Usual Delivery
SLP-002 Signaline LocatorPlus-EN alarm location and interface module	CSSIGLP002	£740.88	1 Week
Signaline FT-78-EN Non-resettable Linear heat detector 78°C	CSSIGFTE01	£4.26	1 Week
Signaline FT-88-EN Non-Resettable Linear Heat Detector 88°C	CSSIGFTE02	£4.26	1 Week
Signaline FT-EOL-EN Two Zone End of Line with test switches	CSSIGEL003	£182.28	1 Week

WATER DETECTION



Signaline water detection cable can be used to protect critical applications where equipment might be vulnerable to water ingress.

Water Detection Control Panels

Description	Part No	List Price	Usual Delivery
2 zone water detection control panel	ESWD-2	£247.04	1 Week
4 zone water detection control panel	ESWD-4	£276.11	1 Week
Recessing bezel	FMK-ECL	£60.73	Stock



Signaline Water Detection Cable

Description	Part No	List Price	Usual Delivery
Signaline WDM-KM monitor c/w EOL plug	CSSIGWC002	£332.22	Stock
Water leak detection cable 3.75m	CSSIGWD001	£113.87	Stock
Water leak detection cable 7.5m	CSSIGWD002	£168.80	Stock
Water leak detection cable 15m	CSSIGWD003	£256.79	Stock
Water leak detection cable 30m	CSSIGWD004	£428.67	1 Week
Nylon P clip (bag of 100pcs)	CCPCLIP008	£46.89	1 Week
10m terminated non sensing cable	CSSIGWA001	£117.22	1 Week
Signaline WIB, water interface box	CSSIGWB001	£70.33	1 Week



INTRINSICALLY SAFE EQUIPMENT

Detectors (Apollo Orbis)

Description	Part No	List Price	Usual Delivery
I.S optical smoke detector	ORB-OP-52027	£114.71	1 Week
I.S multisensor	ORB-OH-53027	£138.47	1 Week
I.S A1R heat detector	ORB-HT-51145	£97.40	1 Week
I.S detector base	ORB-MB-50018	£12.74	1 Week



Manual Call Points

Description	Part No	List Price	Usual Delivery
I.S red indoor call point, surface, 470Ω	MCP1A-R-470-SR-IS	£18.80	1 Week
I.S red waterproof call point, 470Ω	WCP1A-R-470-IS	£116.06	1 Week



Sounders & Visual Indicators

Description	Part No	List Price	Usual Delivery
Intrinsically safe Minialarm sounder, red	IS-MA1	£290.18	1 Week
Intrinsically safe Minialite beacon, red lens	IS-MB1	£323.34	1 Week
Intrinsically safe Minialert sounder/beacon, red	IS-MC1	£497.27	1 Week



Barriers

Description	Part No	List Price	Usual Delivery
Isolating barrier for detection zones, 2 channel	MTL5561	£581.75	1 Week
Solenoid alarm driver for sounder circuits, 45mA	MTL5525	£341.60	1 Week
Shunt diode safety barrier	MTL7728+	£185.37	1 Week
Mounting cabinet for up to 4 barriers	MTLDX070	£244.58	1 Week



Apollo XP95 Addressable Detectors

Description	Part No	List Price	Usual Delivery
I.S. optical smoke detector	55000-640	£232.50	1 Week
I.S. heat detector	55000-440	£232.50	1 Week
I.S. detector base	45681-215	£15.49	1 Week



FLAME PROOF EQUIPMENT

Call Points & Push Buttons

Description	Part No	List Price	Usual Delivery
Exd Break glass call point	BEXCP3A-BG	£282.74	1 Week
Exd Push button call point	BEXCP3A-PB	£415.75	1 Week



Audio Visual Alarms

Description	Part No	List Price	Usual Delivery
Exd sounder, 24vdc	BEXS110D	£1196.76	1 Week
Exd beacon, 24vdc, 5l, red lens	BEXBG05D	£1014.64	1 Week
Exd omnidirectional horn & strobe, red, red lens	BEXDCS11005DR	£1971.72	1 Week



TALENTUM FLAME DETECTORS



Talentum IR & UV Flame Detectors

Description	Part No	List Price	Usual Delivery
IR2 Dual IR	TAL16581	£2270.11	1 Week
IR2 Dual IR, intrinsically safe	TAL16571	£2397.64	1 Week
IR2 Dual IR flameproof (Exd)	TAL16511	£2522.00	1 Week
IR3 Triple IR	TAL16589	£2569.82	1 Week
IR3 Triple IR, intrinsically safe	TAL16579	£2595.34	1 Week
IR3 Triple IR flameproof (Exd)	TAL16519	£2936.48	1 Week
IR3 Triple IR flameproof (Exd) high temperature	TAL16219	£3398.80	1 Week
UV/IR2 UV & Dual IR	TAL16591	£2649.53	1 Week
UV/IR2 UV & Dual IR high temperature	TAL16291	£2942.87	1 Week
Adjustable mounting bracket	TAL07127	£172.18	1 Week
Stainless steel weather shield	TAL12545	£251.88	1 Week



MICROPACK FLAME DETECTION

MICROPACK FIRE & GAS A Consilium Group Company

FDS303 – Multi Spectrum IR Flame Detector - 5 year warranty

Description	Part No	List Price	Usual Delivery
IR3, Aluminium, 2xM25, FM, ATEX, IECEx, SIL 2, EN54-10, FM3260	2200-0021-1	£2210.85	1 Week
IR3, Aluminium, 2x3/4 NPT, FM, ATEX, IECEx, SIL 2, EN54-10, FM3260	2200-0021-5	£2399.67	1 Week
IR3, 316 SS, 2xM25, FM, ATEX, IECEx, SIL 2, EN54-10, FM3260	2200-0021-9	£2399.67	1 Week
IR3, 316 SS, 2x3/4" NPT, FM, ATEX, IECEx, SIL 2, EN54-10, FM3260	2200-0021-13	£2536.17	1 Week

FDS301 Intelligent Visual Flame Detector – Live CCTV Video - 3 year warranty

Description	Part No	List Price	Usual Delivery
ivFD, Aluminium, 2xM25, FM, ATEX, IECEx, SIL 2, EN54-10, FM3260	2200-0023-1	£6115.20	6 Weeks
ivFD, Aluminium, 2x3/4"NPT, FM, ATEX, IECEx, SIL 2, EN54-10, FM3260	2200-0023-5	£6115.20	6 Weeks

FDS300 Intelligent Visual Flame Detector – No Video - 3 year warranty

Description	Part No	List Price	Usual Delivery
ivFD, Aluminium, 2xM25, FM, ATEX, IECEx, FM3260	2200-0030-1	£3822.00	6 Weeks
ivFD, Aluminium, 2x3/4"NPT, FM, ATEX, IECEx, FM3260	2200-0030-5	£3822.00	6 Weeks

Accessories

Description	Part No	List Price	Usual Delivery
FS301 flame simulator, test case and charger	2200-0700	£6153.42	6 Weeks
Detector sealing kit - metric (gland seals and O ring set)	2200-0026	£125.58	6 Weeks
Flame simulator charger (spare)	2200-0501	£363.09	6 Weeks
FDS Series sunshield	3100-0020	£436.80	6 Weeks



Order before 3.00pm for sameday despatch



SOLO DETECTOR TEST EQUIPMENT

A complete range of test and maintenance equipment for smoke, heat and CO detectors.

Testing equipment must be proven to be safe for the engineer and the system, it needs to be cost-effective, versatile, portable, approved by all detector manufacturers and in compliance with international codes and standards.



The Solo range meets all of these requirements.

Solo Test Cans

Description	Part No	List Price	Usual Delivery
Smoke test can, 250ml (flammable) for use with SOLO330 dispenser	SOLO-A5	£22.96	Stock
Smoke test can, 250ml (HFC free, non-flammable) for use with SOLO330 dispenser	SOLO-A10S	£71.69	Stock
CO test can, 250ml for use with SOLO330 dispenser	SOLO-C3	£32.49	Stock
Hand held detector test can, 150ml	SMOKESABRE	£20.15	Stock



Solo Poles & Accessories

Description	Part No	List Price	Usual Delivery
Smoke & CO test can dispenser	SOLO330	£253.82	Stock
4 section telescopic pole, 4.5 metres	SOLO100	£468.73	Stock
2 section telescopic pole, 2.5 metres	SOLO108	£236.42	Stock
Extension pole, 1.13 metres	SOLO101	£137.85	Stock
Universal detector removal tool	SOLO200	£291.98	Stock
Protective storage bag (includes pole bag)	SOLO610	£189.34	Stock



Solo Cordless Heat Detector Tester

Description	Part No	List Price	Usual Delivery
Cordless heat detector test kit. Includes: 1 x SOLO460 cordless heat detector head unit 2 x SOLO770 battery baton 1 x SOLO727 fast charger	SOLO461	£1067.54	Stock
Cordless heat detector head unit only	SOLO460	£643.14	Stock
Battery baton	SOLO770	£193.03	Stock
220/240v mains & car charger	SOLO727	£173.25	Stock





NEW

NEW SOLO 365 SMOKE DETECTOR TESTER

Solo 365 is an exciting, new innovation for testing smoke detectors. It offers everything the industry expects from the popular Solo brand, pairing it with the very latest technology and wrapping it in a new modern slim-line design.

No more bulky aerosol cans



Faster, Simple, Cleaner

Solo 365 Smoke Detector Test Equipment

Description	Part No	List Price	Usual Delivery
SOLO365 smoke detector tester set	SOLO365	£982.46	Stock
SOLO365 smoke cartridge	SOLO-ES3	£41.88	Stock
SOLO365 spare battery pack	SOLO370	£236.60	Stock
SOLO365 spare smoke generator	SOLO371	£327.03	1 Week
SOLO365 ASD system testing adaptor	SOLO372	£138.84	1 Week



ASD Adaptor

Solo 365 Smoke Detector Test Kits

Solo™ Model No	Access Height (approx max)	Solo365 Detector Tester	Solo100 Access Pole	Solo101 Extension Pole	Solo108 Access Pole	Solo200 Removal Tool	Solo610 Carrying Bag	List Price	Usual Delivery
SOLO908	4.0m	•			•			£1386.32	1 Week
SOLO909	6.0m	•	•					£1615.19	1 Week
SOLO911	6.0m	•	•			•	•	£2091.20	1 Week
SOLO900	9.3m	•	•	• (x3)		•	•	£2463.48	1 Week



Solo Detector Testing Kits

The range of Solo testing tools are available in economical and convenient kit formats.

Solo Testing Kits

Solo™ Model No	Smoke Testing	Heat Testing	CO Testing	Access Height (approx max)	Solo330 Aerosol Dispenser	Solo461 Cordless Heat Tester	Solo424 Mains Heat Tester	Solo100 Access Pole	Solo101 Extension Pole	Solo108 Access Pole	Solo200 Removal Tool	Solo610 Carrying Bag	List Price	Usual Delivery
SOLO808	•		•	4.0m	•					•			£515.01	1 Week
SOLO810	•		•	2.5m	•				•				£368.84	1 Week
SOLO812	•		•	8.2m	•			•	• (x2)		•	•	£1451.48	Stock
SOLO814	•	•	•	6.0m	•		•	•			•	•	£1879.13	1 Week
SOLO822	•	•	•	6.0m	•	•		•			•	•	£2256.58	Stock
SOLO823	•	•	•	9.3m	•	•		•	• (x3)		•	•	£2415.92	Stock

TESTIFIRE DETECTOR TEST EQUIPMENT



Testifire is the world's first all-in-one detector tester.

It enables fast and efficient testing of Smoke, Heat and CO making it suitable for both single and multi-sensor detectors.



Testifire All-In-One Detector Tester 'Heads Sets'

Description	Part No	List Price	Usual Delivery
Testifire smoke & heat set. Includes: 1 x TESTIFIRE 1000 head unit 1 x TS3-001 smoke capsule 2 x SOLO770 battery baton 1 x SOLO727 fast charger	TESTIFIRE1001	£1670.99	Stock
Testifire smoke, heat & CO set. Includes: 1 x TESTIFIRE 2000 head unit 1 x TS3-001 smoke capsule 1 x TC3-001 CO capsule 2 x SOLO770 battery baton 1 x SOLO727 fast charger	TESTIFIRE2001	£1983.49	Stock



Testifire All-In-One Detector Tester (Head Only)

Description	Part No	List Price	Usual Delivery
Testifire smoke & heat head unit only	TESTIFIRE1000	£1375.89	Stock
Testifire smoke heat & CO head unit only	TESTIFIRE2000	£1792.88	Stock

Testifire Replacement Capsules

Description	Part No	List Price	Usual Delivery
Testifire smoke capsule, 3 pack	TS3-3PACK	£214.18	Stock
Testifire smoke capsule, 6 pack	TS3-6PACK	£413.04	Stock
Testifire CO capsule, 6 pack	TC3-6PACK	£431.95	1 Week



Testifire All-In-One Detector Tester Kits

Description	Part No	List Price	Usual Delivery
Testifire smoke & heat kit. Includes: 1 x TESTIFIRE1000 head unit 1 x TS3-001 smoke capsule 2 x SOLO770 battery baton 1 x SOLO727 fast charger 1 x SOLO100 telescopic pole, 4.5m 3 x SOLO101 extension pole, 1.13m 1 x SOLO200 universal detector removal tool 1 x SOLO610 protective storage bag	TESTIFIRE9001	£3013.90	Stock
Testifire smoke, heat & CO kit. Includes: 1 x TESTIFIRE2000 head unit 1 x TS3-001 smoke capsule 1 x TC3-001 CO capsule 2 x SOLO770 battery baton 1 x SOLO727 fast charger 1 x SOLO100 telescopic pole, 4.5m 3 x SOLO101 extension pole, 1.13m 1 x SOLO200 universal detector removal tool 1 x SOLO610 protective storage bag	TESTIFIRE9201	£3188.27	1 Week



The all-in-one test solution, Testifire allows for compliant functional testing of heat, smoke and CO fire detectors whether they are single or multi-sensor detectors.



URBAN KITS

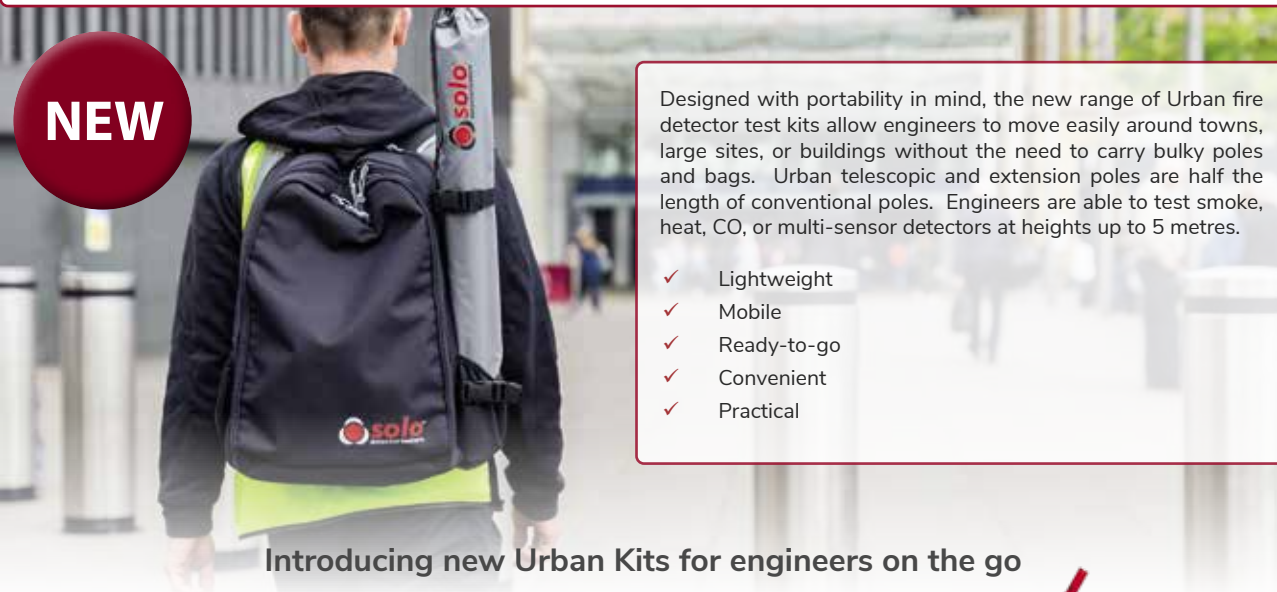

Designed with portability in mind, the new range of Urban fire detector test kits allow engineers to move easily around towns, large sites, or buildings without the need to carry bulky poles and bags. Urban telescopic and extension poles are half the length of conventional poles. Engineers are able to test smoke, heat, CO, or multi-sensor detectors at heights up to 5 metres.

- ✓ Lightweight
- ✓ Mobile
- ✓ Ready-to-go
- ✓ Convenient
- ✓ Practical

Introducing new Urban Kits for engineers on the go

Urban Test Kits

Description	Part No	List Price	Usual Delivery
SOLO Urban Kit Backpack & Poles to 5M	SOLO613	£1255.80	1 Week
Urban Testfire Smoke/Heat Test Kit to 5M	URBAN1001-1	£2827.29	1 Week
Urban Testfire Smoke/Heat/CO Test Kit to 5M	URBAN2001-1	£3159.92	1 Week
Urban SOLO365 Smoke Test Kit to 5M	URBAN365	£2118.41	1 Week
Urban Kit Pole Bag	SOLO612	£37.65	1 Week



SCORPION DETECTOR TEST EQUIPMENT



scorpion®

Scorpion is a new, innovative solution for testing smoke detectors and aspirating detection systems installed in hard-to-access locations. A Scorpion head unit is a smoke generator installed next to the detector. When required it generates smoke which is directed towards the detector providing a safe functional test.

No more struggling with those hard-to-access detectors. No access? No excuses

Do you have sites with hard to access detectors? Do you sometimes turn away service contracts because of the potential cost of having to hire specialist equipment or services in order to test devices in lift shafts, void spaces or on high ceilings?

Scorpion could be the ideal solution for you and your clients.



Scorpion Tester Equipment

Description	Part No	List Price	Usual Delivery
Scorpion point detector test head	SCORP1001	£435.40	1 Week
Scorpion ASD head unit kit	SCORP2001	£410.75	1 Week
Scorpion wall mounted control panel	SCORP8000	£795.60	1 Week
Scorpion access point	SCORP25	£108.45	1 Week
Scorpion engineers portable controller	SCORP7000	£1289.68	1 Week



MCP CALL POINTS



THE INTELLIGENT CHOICE

KAC offer an unparalleled range of indoor and outdoor, break glass, re-settable and key operated call points.



Red Indoor Models

TW

Description	Part No	List Price	Usual Delivery
470Ω resistor/short circuit - front only	MCP1A-R-470	£8.57	Stock
Twin Wire call point - front only	MCP1B-R-TW	£11.55	Stock
Call point back box for above	MCPBB-R	£1.88	Stock
Resettable call point 470Ω c/w back box	MCP1A-R-470-SR-R	£11.99	Stock
470Ω resistor/short circuit with LED c/w back box	MCP2A-R-470-SR	£16.93	1 Week
Universal transparent hinged cover	PS200	£3.79	Stock



Back box & hinged cover available separately

Other Colour Indoor Models, Single Pole - c/w Back Box

Description	Part No	List Price	Usual Delivery
Yellow, 470Ω/short cct. EXTINGUISHANT RELEASE	MCP1A-Y-470-SY	£17.72	Stock
Yellow, NO/NC. NO FUNCTION MARKING	MCP3A-Y-SY	£18.37	Stock
Green, NO/NC. EMERGENCY DOOR RELEASE	MCP3A-G-SG	£18.37	Stock
White, NO/NC. NO FUNCTION MARKING	MCP3A-W-SW	£18.13	1 Week
Blue, NO/NC. BOMB ALARM	MCP3A-B-SB	£18.37	1 Week



Other Colour Indoor Models, Double Pole - c/w Back Box

Description	Part No	List Price	Usual Delivery
Yellow, NO/NC. NO FUNCTION MARKING	MCP4A-Y-SY	£42.01	1 Week
Green, NO/NC. EMERGENCY DOOR RELEASE	MCP4A-G-SG	£42.01	1 Week
White, NO/NC. NO FUNCTION MARKING	MCP4A-W-SW	£42.01	1 Week
Blue, NO/NC. BOMB ALARM	MCP4A-B-SB	£42.01	1 Week



Triple pole call points also available - please enquire

Waterproof Models - IP67

TW

Description	Part No	List Price	Usual Delivery
Red, 470Ω/short cct. EURO FLAME LEGEND	WCP1A-R-470	£80.78	Stock
Twin Wire call point. EURO FLAME LEGEND	WCP1B-R-TW	£85.78	Stock
Red, NO/NC. EURO FLAME LEGEND	WCP3A-R	£78.30	1 Week
Yellow, NO/NC. NO FUNCTION MARKING	WCP3A-Y	£93.58	1 Week
Green, NO/NC. EMERGENCY DOOR RELEASE	WCP3A-G	£93.58	1 Week
White, NO/NC. NO FUNCTION MARKING	WCP3A-W	£89.52	1 Week
Blue, NO/NC. BOMB ALARM	WCP3A-B	£93.58	1 Week



KEY OPERATED CALL POINTS

The KAC range of keyswitch devices provides a comprehensive selection of switching product solutions for fire, security and other specialist applications.

All products comprise a main housing and escutcheon plate and can be supplied in red, green, white, yellow or blue.

The standard keyswitch family can be supplied as 2 or 3 position switches, with single or double pole relays. The 2 position switch can be provided with the key removable in both positions or trapped in position one.

2 Position, Single Pole - Key Removable In Both Positions

Description	Part No.	List Price	Usual Delivery
Red, FIRE (EURO HOUSE FLAME)	WRK20S01-SR	£30.01	Stock
Green, EMERGENCY DOOR RELEASE	WGK20S12-SG	£30.33	Stock
Yellow, NO FUNCTION MARKING	WYK20S11-SY	£30.33	Stock
White, NO FUNCTION MARKING	WWK20S11-SW	£30.33	Stock
Blue, NO FUNCTION MARKING	WBK20S11-SB	£30.33	1 Week
Orange, NO FUNCTION MARKING	WAK20S11-SA	£38.25	1 Week

2 Position, Single Pole - Key Trapped In Position 1

Description	Part No.	List Price	Usual Delivery
Red, FIRE (EURO HOUSE FLAME)	WRK21S01-SR	£30.01	Stock
Green, EMERGENCY DOOR RELEASE	WGK21S12-SG	£30.33	Stock
Yellow, NO FUNCTION MARKING	WYK21S11-SY	£30.33	Stock
White, NO FUNCTION MARKING	WWK21S11-SW	£30.33	Stock
Blue, NO FUNCTION MARKING	WBK21S11-SB	£30.33	1 Week

3 position switches and other variations available - please enquire

KAC CALL POINT ACCESSORIES

Description	Part No	List Price	Usual Delivery
Universal transparent hinged cover	PS200	£3.79	Stock
Call point back box, red	MCPBB-R	£1.88	Stock
Pack of 5 breakable seals for PS200 covers	M357	£23.75	Stock
Frangible element, glass replacement	PS210	£1.23	Stock
Pack of 5 replacement glasses	KG1	£5.02	Stock
Pack of 10 universal test keys	K-TK	£5.02	Stock
KAC call point conversion kit, black bezel	TB16	£18.14	Stock
Pack of 6 spare keys for 2 Position key switch call points	SC086	£27.66	Stock
Pack of 6 spare keys for 3 Position key switch call points	SC087	£27.66	1 Week

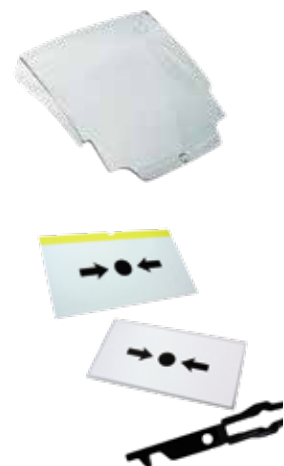

Resettable Call Points

STI RESETTABLE CALL POINTS

A purpose designed resettable call point. Available for indoor and outdoor use, in a variety of colours.

Type '01' models are supplied with both 470Ω & 680Ω resistors fitted. Type '11' models have no resistors, but 2 sets of changeover contacts which can be configured to switch independently or double pole.



Red Indoor Models

Description	Part No	List Price	Usual Delivery
Red, EURO FLAME LEGEND	RP-RD2-01	£16.49	Stock
Twin Wire call point. EURO FLAME LEGEND	RP-RD2-TW	£18.85	Stock



Indoor Models - Type '11'

Description	Part No	List Price	Usual Delivery
Red with Euro flame legend	RP-RD2-11	£26.91	1 Week
Yellow, supplied with std function label set	RP-YD2-11	£26.42	1 Week
Green with running man legend	RP-GD2-11	£26.42	1 Week
White, supplied with std function label set	RP-WD2-11	£26.42	1 Week
Blue, supplied with std function label set	RP-BD2-11	£26.42	1 Week
Orange, supplied with std function label set	RP-OD2-11	£26.42	1 Week



Supplied with standard function marking kit. Custom labels available POA

Waterproof Models

Description	Part No	List Price	Usual Delivery
Red, EURO FLAME LEGEND	WRP2-R-01	£75.67	1 Week
Twin Wire call point. EURO FLAME LEGEND	WRP2-R-TW	£81.29	1 Week



Resettable Call Point Accessories

Description	Part No	List Price	Usual Delivery
Clear integral hinged cover	CI	£4.58	Stock
Spare reset key, pack of 10	RP-K-10	£9.50	Stock



EATON FULLEON CXL UNIVERSAL CALL POINTS

The Fulleon Universal call point has both 470Ω & 680Ω resistors fitted and is supplied with an operated LED indicator, surface back box and interchangeable glass and plastic (resettable) operating elements.



Powering Business Worldwide

Universal Call Point

Description	Part No	List Price	Usual Delivery
Red, Indoor, EURO FLAME LEGEND	CXL-U-R-BB	£10.71	Stock
Red, Waterproof - IP67, EURO FLAME LEGEND	CXL-U-R-WP	£48.44	2 Weeks
Pack of 10 clear hinged covers	CX-PC	£33.75	Stock
Pack of 10 spare test/reset keys	CX-UK	£5.33	Stock
Pack of 10 spare glasses	CX-SG	£8.87	Stock



EURO STOPPER CALL POINT COVERS
STI Euro Stopper® Multi Kit with *Glow Guide*

This newly styled protective cover further enhances the Stopper® range. The Multi Kit comes with one polycarbonate cover, 2 coloured housing shells (red & green), 1 break seal and 2 label sheets in 13 languages.

The Glow Guide is a unique material that is embedded in the perimeter of the frame and illuminates in the dark creating a radiant glow around the manual call point making it easier to locate in dark areas.



- ✓ Supplied with both red & green coloured housing shells
- ✓ Supplied with label sheets in 13 languages
- ✓ Optional 96dB deterrent sounder with low battery warning
- ✓ Accommodates flush and surface mount applications
- ✓ Unique *Glow Guide* material embedded into frame



Description	Part No	List Price	Usual Delivery
Euro Stopper Multi Kit flush mount	STI15010ML	£42.76	Stock
Euro Stopper Multi Kit surface mount	STI15C10ML	£58.32	Stock
Euro Stopper Multi Kit + sounder, flush mount	STI15020ML	£93.41	Stock
Euro Stopper Multi Kit + sounder, surface mount	STI15C20ML	£107.36	Stock

UNIVERSAL STOPPER COVER

These indoor and outdoor polycarbonate covers protect devices such as manual call points, emergency buttons and dual action pull stations etc., without restricting legitimate operation. Available with or without a 95dB integral sounder.



Description	Part No	List Price	Usual Delivery
Universal Stopper, flush, red, FIRE	STI13010-FR	£54.63	Stock
Universal Stopper with sounder, flush, red, FIRE	STI13020-FR	£103.77	Stock
Universal Stopper, surface, red, FIRE	STI13110-FR	£69.29	Stock
Universal Stopper with sounder, surface, red, FIRE	STI13120-FR	£118.35	Stock
Low profile Univ Stopper, flush, red, FIRE	STI14010-FR	£58.83	1 Week
Low profile Univ Stopper, surface, red, FIRE	STI14110-FR	£72.55	1 Week
Low profile Univ Stopper + sndr, flush, red, FIRE	STI14020-FR	£111.74	1 Week
Low profile Univ Stopper + sndr, surface, red, FIRE	STI14120-FR	£127.45	1 Week

Other colours and variations available - please enquire

ENVIRO STOPPER WATERPROOF CALL POINT COVER

The Enviro Stopper® is a tough polycarbonate housing ideal for use in wet or wash down areas. It offers protection against dust and water ingress both inside and outside as well as preventing tampering, vandalism and damage from accidental or malicious operation. Available with or without a 95dB integral sounder.



Description	Part No	List Price	Usual Delivery
Enviro Stopper, red with fire label	STI13610-FR	£175.11	1 Week
Enviro Stopper + sounder, red with fire label	STI13620-FR	£239.72	1 Week

Other colours and variations available - please enquire



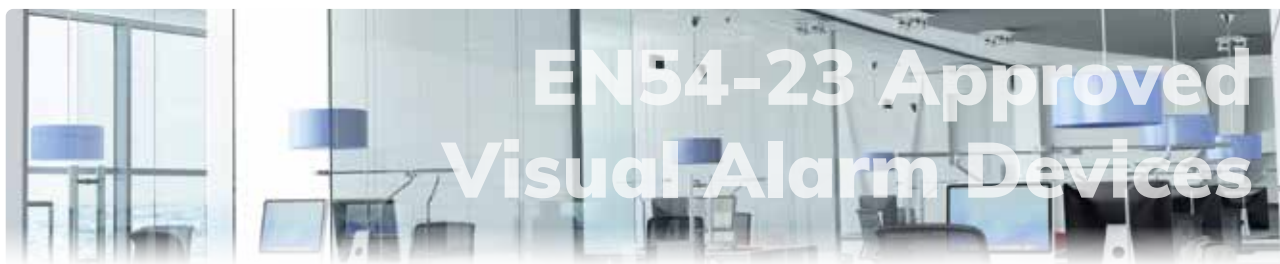

FULLEON VISUAL ALARM DEVICES - EN54-23 APPROVED



SQG3 Platform Sounder VAD Open Class

18-35vdc, 8.7-11mA, white flash

Description	Part No	List Price	Usual Delivery
SQG3 base/platform sounder VAD - Open Class	SQG3-23	£64.97	Stock
Pack of 5 blanking covers, white	SQG3-CVR-W	£9.67	Stock



Solista LX Wall Mounted VADs

9-60vdc, 10-25mA, red flash, IP33C shallow base, IP65 deep or 'U' base

Description	Part No	List Price	Usual Delivery
Red, red flash, shallow base, IP33C - W-2.4-7.5	SOL-LX-W-RF-R-S	£49.63	Stock
Red, red flash, deep base, IP65 - W-2.4-7.5	SOL-LX-W-RF-R-D	£49.63	Stock
Red, red flash, U base, IP65 - W-2.4-7.5	SOL-LX-W-RF-R-U	£48.70	Stock
White, red flash, shallow base, IP33C - W-2.4-7.5	SOL-LX-W-RF-W-S	£48.70	Stock
White, red flash, deep base, IP65 - W-2.4-7.5	SOL-LX-W-RF-W-D	£48.70	Stock
White, red flash, U base, IP65 - W-2.4-7.5	SOL-LX-W-RF-W-U	£51.14	Stock



Also available with white flash - please enquire

Solista LX Ceiling Mounted VADs

9-60vdc, 10-25mA, red flash, IP33C shallow base, IP65 deep or 'U' base

Description	Part No	List Price	Usual Delivery
White, red flash, shallow base, IP33C - C-3-7.5	SOL-LX-C-RF-W-S	£49.63	Stock
White, red flash, deep base, IP65 - C-3-7.5	SOL-LX-C-RF-W-D	£49.63	Stock



Also available with white flash - please enquire

FULLEON VISUAL ALARM DEVICES FOR USE WITH WALL MOUNTED SOUNDERS - EN54-23 APPROVED

ROLP LX VAD Base For Roshni Sounders (Sounders Sold Separately)

18-28vdc, 22-37mA (Incl Roshni sounder), red flash, IP65, for wall mounting

Description	Part No	List Price	Usual Delivery
Red unit, red flash - W-2.4-7.5	ROBASE-LX-W-RF-R	£49.79	Stock
White unit, red flash - W-2.4-7.5	ROBASE-LX-W-RF-W	£49.79	Stock



Also available with white flash - please enquire

Symphoni LX VAD Base For Symphoni Sounders (Sounders Sold Separately)

18-28vdc, 15-30mA (Incl Symphoni sounder), red flash, IP21C, for wall mounting

Description	Part No	List Price	Usual Delivery
Red unit, red flash - W-2.4-7.5	SYBASE-LX-W-RF-R	£48.83	Stock
White unit, red flash - W-2.4-7.5	SYBASE-LX-W-RF-W	£51.27	Stock



Also available with white flash - please enquire

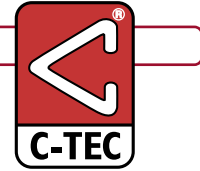

C-TEC VISUAL ALARM DEVICES - EN54-23 APPROVED

ActiV Base Sounder VADs

18-30vdc, 12.2-25mA, 96dB(A) sounder, white flash

Description	Part No	List Price	Usual Delivery
Base/platform sounder VAD, IP21C - C-3-8.5	BF456C-CC-W	£59.83	1 Week
Base/platform corridor sounder VAD, IP21C - O-R-3-2.5-17	BF432C-CC-W	£54.34	1 Week
White blanking cap for stand alone use	BF330CTLIDW	£4.16	1 Week
Red blanking cap for stand alone use	BF330CTLIDR	£4.16	1 Week



ActiV High Output Wall Mounted Sounder VADs

18-30vdc, 12.2-25mA, 100dB(A) sounder, white flash

Description	Part No	List Price	Usual Delivery
Red, white flash, shallow base, IP21C - W-2.75-9	BF433C-CC-SR	£61.89	1 Week
Red, white flash, deep base, IP33C - W-2.75-9	BF433C-CC-DR	£64.18	1 Week
Red, white flash, deep base, IP55C - W-2.75-9	BF433C-CC-DR-65	£91.99	1 Week



Other Sounders & Beacons with Non EN54-3 Beacons (VIDS)

CRANFORD CONTROLS ELECTRONIC SOUNDERS & BEACONS



Description	Part No	List Price	Usual Delivery
VSO base/platform sounder, white	CC-507-001	£21.41	Stock
VTG wall sounder, red, deep base	CC-510-019	£22.42	Stock
VTB sounder/beacon, red body, red lens, shallow base	CC-511-095L	£47.56	Stock
VTB sounder/beacon, red body, red lens, deep base	CC-511-097L	£47.84	Stock
VTB sounder/beacon red c/w 30 min time out	CC-511-090L	£57.74	1 Week



KLAXON ELECTRONIC SOUNDERS & BEACONS



Description	Part No	List Price	Usual Delivery
Sonos sounder, red, deep base	PSS-0020	£21.53	Stock
Sonos sounder/LED beacon, red lens, red shallow base	PSC-0047	£45.82	Stock
Sonos sounder/LED beacon, red lens, red deep base	PSC-0042	£45.00	Stock



FULLEON ELECTRONIC SOUNDERS

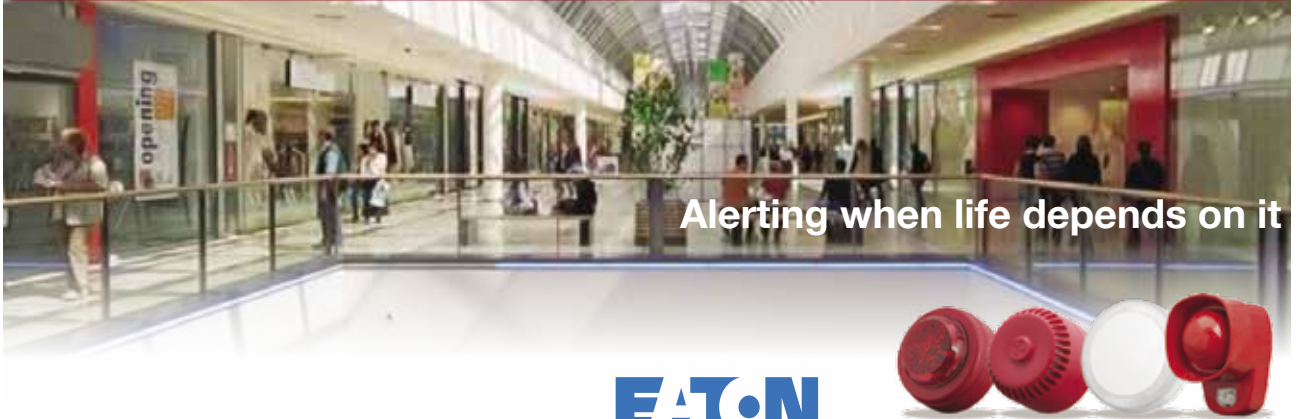

Squashni Base/Platform Sounders

24vdc. 93dB(A) - tone 3, 18mA

Description	Part No	List Price	Usual Delivery
Squashni sounder, std white	SQ-03-W	£25.48	Stock
Blanking cover, std white	SQ-CVR-W	£2.08	Stock



Roshni Wall Mounted Sounders

24vdc. 102dB(A) - tone 3, 16mA. IP65 if used with deep or 'U' base

Description	Part No	List Price	Usual Delivery
Roshni sounder, red, c/w deep base	ROLP-R-D	£21.50	Stock



Symphoni Wall Mounted Sounders

24vdc. 102dB(A) - tone 3, 16mA. IP65 if used with deep or 'U' base

Description	Part No	List Price	Usual Delivery
Red, low current. 100dB(A) - tone 3, 5mA	SY-R	£36.43	Stock
Red, high O/P. Up to 120dB(A), 240mA	SYHO-R	£91.52	Stock
Red, high O/P, waterproof. Up to 120dB(A), 240mA	SYHO-R-WP	£130.78	2 Weeks



Askari Compact Sounders

24vdc. 97dB(A) - tone 3, 18mA

Description	Part No	List Price	Usual Delivery
Red sounder, front only	AC-03-R	£21.42	Stock
White sounder, front only	AC-03-W	£21.42	Stock
Red back box	AC-BOX-R	£4.32	Stock
White back box	AC-BOX-W	£3.22	Stock



FULLEON BELLS

Motorised Centrifugal Bell

24vdc

Description	Part No	List Price	Usual Delivery
6" bell, red, 93-95dB(A), 25mA	CFB6D-24	£25.17	Stock



Electronic Solenoid Bells

6 inch

Description	Part No	List Price	Usual Delivery
Red, 24vdc, 93-95dB(A), 30mA	FB024	£34.27	Stock
Red, 24vdc, weatherproof, 93-95dB(A), 30mA	FB024-WP	£42.41	Stock
Red, 230vac, 93-95dB(A), 25mA	FB240-R	£42.41	Stock
Red, 230vac, weatherproof, 93-95dB(A), 25mA	FB240-R-WP	£59.36	Stock



FULLEON VISUAL INDICATORS

Solista Low Current LED Visual Indicator (Bases Sold Separately)

24vdc, 6mA, red lens. IP65 if used with deep or 'U' base

Description	Part No	List Price	Usual Delivery
Red LED beacon, no base	SOL-RL-R	£35.41	Stock



Solex Xenon Visual Indicator (Bases Sold Separately)

24vdc, 35mA, 3 Candelas. IP65 if used with deep or 'U' base

Description	Part No	List Price	Usual Delivery
Red lens xenon beacon, no base	SO-R-3C	£31.41	Stock
Amber lens xenon beacon, no base	SO-A-3C	£35.74	1 Week



FULLEON COMBINED SOUNDER/VISUAL INDICATORS

SQG3-VID Base/Platform Sounder/Low Current LED Visual Indicator

24vdc, 90dB(A) - high volume, 11mA, red flash.

Description	Part No	List Price	Usual Delivery
Sounder/LED beacon, white, red flash	SQG3-VID	£75.82	Stock
Pack of 5 white blanking covers for SQG3	SQG3-CVR-W	£9.67	Stock



Roshni SB & Flashni Sounder/Visual Indicator

24vdc, 102dB(A) - tone 3, red lens. IP65 if used with deep or 'U' base

Description	Part No	List Price	Usual Delivery
Roshni SB red sndr/LED beacon, deep base, 21mA	ROLPSB-RL-R-D	£58.81	Stock
Flashni red sndr/xenon beacon, deep base, 68mA	FL-RL-R-D	£71.37	Stock



FULLEON BASES

Range of Bases for Fulleon Sounders & Visual Indicators

Description	Part No	List Price	Usual Delivery
Red shallow base	SBASE-R	£2.57	Stock
White shallow base	SBASE-W	£2.78	Stock
Red deep base (IP65)	DBASE-R	£2.73	Stock
White deep base (IP65)	DBASE-W	£2.78	Stock
Red 'U' base (IP65)	UBASE-R	£2.57	Stock
White 'U' base (IP65)	UBASE-W	£3.55	Stock
Red mains conversion base	MAINSBASE-R	£18.12	Stock
White mains conversion base	MAINSBASE-W	£18.54	Stock



PROTECTIVE CAGES FOR SOUNDERS & BELLS

Protective Cages For Sounders, Beacons & Bells

Description	Part No	List Price	Usual Delivery
149mm Di x 127mm D, medium	STI9617	£38.78	Stock
198mm Di x 152mm D, large	STI9614	£46.30	Stock
210mm Di x 108mm D. For up to 8" bell	STI9602	£38.25	1 Week

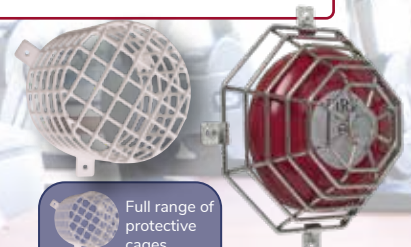

Full range of protective cages
Page 77

VIMPEX ELECTRONIC SOUNDERS

Vimpex Base/Platform Sounders

24vdc. 90.4dB(A) - tone 2, 15mA

Description	Part No	List Price	Usual Delivery
Vimpex base sounder, white, c/w blanking plate	IDBTS-W	£25.51	Stock



Banshee Excel Wall Mounted Sounders

24vdc. 100dB(A) - tone 2, 12mA

Description	Part No	List Price	Usual Delivery
Red sounder with shallow base	VS-BER-24-S	£26.70	Stock
Red sounder with deep base. Waterproof to IP65	VS-BER-24-D	£28.31	Stock



VIMPEX BELLS

Motorised Bells

24vdc. 96dB(A), 12mA, EN54-3

Description	Part No	List Price	Usual Delivery
ClamBell 24 V 6" shallow base - red	CBE6-RS-024-EN	£24.83	Stock
ClamBell 24 V 6" deep base - red	CBE6-RD-024-EN	£35.85	Stock
ClamBell 24 V 6" weatherproof - red	CBE6-RW-024-EN	£46.90	Stock
Combined Red 6" bell with visual alarm device	SNV0004	£135.80	Stock



VIMPEX COMBINED SOUNDER VISUAL INDICATORS

Banshee Excel Lite Low Current Sounder/LED Visual Indicators

24vdc. 100dB(A) - tone 2, 16mA

Description	Part No	List Price	Usual Delivery
Red with shallow base	VS-BELB-R-RL-S	£66.40	1 Week
Red with deep base. Waterproof to IP66	VS-BELB-R-RL-D	£67.68	1 Week
White with shallow base	VS-BELB-W-RL-S	£66.40	1 Week



Banshee Excel Lite Low Current Sounder/Xenon Visual Indicators

24vdc. 100dB(A) - tone 2, 40mA

Description	Part No	List Price	Usual Delivery
Red sounder, red lens, shallow base	VS-BEXB-R-RL-S	£61.15	Stock
Red sounder, red lens, deep base. IP66	VS-BEXB-R-RL-D	£62.43	Stock
White sounder, red lens, shallow base	VS-BEXB-W-RL-S	£61.15	1 Week
White sounder, red lens, deep base. IP66	VS-BEXB-W-RL-D	£62.43	1 Week



VIMPEX FIRECRYSER VOICE SOUNDERS

FireCryer® Plus & Mini FireCryer® Plus



Description	Part No	List Price	Usual Delivery
Red sounder, shallow base	VS-FC3-A-R-0-S	£131.85	1 Week
Red sounder with LED beacon, shallow base	VS-FC3-A-R-R-S	£165.58	1 Week
Red sounder with LED beacon, deep base, IP66	VS-FC3-A-R-R-D	£165.58	1 Week
White base mounted sounder	VS-FC3-C-W	£119.58	1 Week



MARINE APPROVED CONTROL PANELS

The Esento Marine range from Haes has been exclusively developed to address the issues of limited form and function in the conventional panels market for use at sea.

- ✓ 2 - 12 zones
- ✓ Muster Alarm
- ✓ Programmable delays to outputs
- ✓ Approved by MED, Lloyds Register & ABS

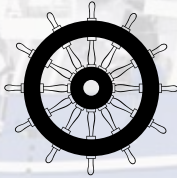

Esento Marine Control Panels

Description	Part No.	List Price	Usual Delivery
2 zone	ESEN-2MAR	£370.61	Stock
4 zone	ESEN-4MAR	£454.84	Stock
8 zone	ESEN-8MAR	£791.76	Stock
12 zone	ESEN-12MAR	£993.90	Stock
12 zone repeater panel	ESEN-R-12MAR	£377.75	Stock

MARINE APPROVED DEVICES

A range of fire alarm devices which are approved for use in the marine and offshore environment.

These devices operate in the same way but are subject to additional approvals tests, specific to the marine environment.



Marine Fire System Devices

Description	Part No	List Price	Usual Delivery
Orbis Marine optical smoke detector	ORB-OP-42001-MAR	£56.01	3 Working Days
Orbis Marine multisensor detector	ORB-OH-43001-MAR	£64.16	3 Working Days
Orbis Marine A1R heat detector	ORB-HT-41001-MAR	£29.57	3 Working Days
Orbis Marine BS heat detector	ORB-HT-41004-MAR	£29.58	3 Working Days
Orbis Marine CS heat detector	ORB-HT-41006-MAR	£29.58	3 Working Days
Orbis Marine TimeSaver base	ORB-MB-00001-MAR	£7.97	3 Working Days
Marine approved indoor call point, red, 470Ω	MCP1A-R-470-SR-R	£11.99	Stock
Marine approved waterproof call point, red, 470Ω	WCP1A-R-470-R	£75.98	1 Week
Marine approved wall sounder, red, shallow base	CC-510-137	£35.49	1 Week
Marine approved wall sounder, red, deep base	CC-510-138	£37.54	1 Week
Marine approved sounder/beacon, red body, red lens, shallow base	CC-511-144	£83.74	1 Week
Marine approved sounder/beacon, red body, red lens, deep base	CC-511-145	£85.55	1 Week



AUTOMATIC OPENING VENT CONTROL PANELS



Available with 1-8 detection circuits and 3A, 5A or 10A PSUs.

- ✓ 1-8 conventional or Twin Wire detector circuits
- ✓ Large LCD graphic display (MZAOV)
- ✓ Vent status indications & controls
- ✓ Vent control switch inputs

TW Twin Wire selectable

AOV Automatic Opening Vent Control Panels

Description	Part No.	List Price	Usual Delivery
Single zone non extendable, 3A PSU	SZAOV-1001	£390.00	Stock
Single zone non extendable, 3A PSU	MZAOV-1001A	£611.00	Stock
2 zone, extendable to 4, 3A PSU	MZAOV-1001	£753.92	Stock
2 zone, extendable to 4, 5A PSU	MZAOV-1002	£904.15	Stock
2 zone, extendable to 8, 10A PSU	MZAOV-1003	£1431.34	Stock
2 zone extension card	MZAOV-3001	£208.65	Stock
PIR, Rain Sensor & BMS add on card	MZAOV-3002	£139.10	Stock

SMOKE VENT SWITCHES

Smoke Vent Manual Call Points (470 Ohm)

Description	Part No	List Price	Usual Delivery
Smoke Vent manual call point, yellow, resettable	MCP1A-Y-AOV	£19.06	Stock
Smoke Vent manual call point, orange, resettable	MCP1A-A-AOV	£18.55	Stock



Smoke Vent Firemans Switch (3 Position, OPEN - AUTO - CLOSE)

Description	Part No	List Price	Usual Delivery
Smoke Vent Firemans Key Switch, yellow	WYK30S-AOV	£39.97	Stock
Smoke Vent Firemans Key Switch, orange	WAK30S-AOV	£43.19	Stock



Smoke Vent Rocker Switch (3 Position, OPEN - AUTO - CLOSE)

Description	Part No	List Price	Usual Delivery
Smoke Vent rocker switch, yellow	WY9203-AOV	£39.91	Stock
Smoke Vent rocker switch, orange	WA9203-AOV	£41.28	Stock



SMOKE VENT ACCESSORIES

Smoke Vent Rain Sensor & PIR

Description	Part No	List Price	Usual Delivery
Rain sensor	GZ140226	£328.22	Stock
Grade 2 Premier Elite TD (PIR)	AFE-0001	£22.93	Stock



WINDOW ACTUATORS

GEZE Chain Drive Slimchain

The GEZE Slimchain is for universal use. This chain can be integrated perfectly into the facade design thanks to its slim and discreet look.



Description	Part No	List Price	Usual Delivery
Slimchain 24v DC/300mm/RH/0.9Amp/EV1 silver	GZ147030	£295.40	Stock
Slimchain 24v DC/300mm/LH/1.1Amp/EV1 silver	GZ147035	£295.40	Stock
Slimchain 24v DC/500mm/RH/1.1Amp/EV1 silver	GZ147040	£327.08	Stock
Slimchain 24v DC/500mm/LH/1.1Amp/EV1 silver	GZ147045	£327.08	Stock
Outward opening bracket/black	GZ147062	£32.82	Stock
Inward opening bracket/black	GZ147060	£32.82	Stock



GEZE Chain Drive Powerchain

The GEZE Powerchain is suitable wherever large forces and very large opening widths are required. In addition, it facilitates fast opening speeds particularly for emergency smoke and heat extraction, even with very heavy windows.

Description	Part No	List Price	Usual Delivery
Powerchain 24v DC/600mm /1.2Amp/EV1 silver	GZ147080	£585.09	Stock
Powerchain 24v DC/800mm /1.5Amp/EV1 silver	GZ147090	£585.09	Stock
Outward bracket/black	GZ147112	£40.98	Stock
Inward opening bracket/black	GZ147110	£36.10	Stock



GEZE Spindle Drive

Heavy and wide casements in particular can be opened and closed by the GEZE E250NT electric motor drive. Individual speeds can be set for ventilation mode.

Description	Part No	List Price	Usual Delivery
E250NT Linear 24v DC/300mm /0.9Amp/EV1 silver	GZ146661	£359.84	Stock
E250NT Linear 24v DC/500mm /0.9Amp/EV1 silver	GZ146664	£386.16	Stock
E250NT Linear 24v DC/750mm /1.1Amp/EV1 silver	GZ146670	£443.09	Stock
E250NT Linear 24v DC/1000mm /1.1Amp/EV1 silver	GZ146673	£518.57	Stock
Standard console/silver	GZ19032	£65.65	Stock
Swivelling console/silver	GZ116112	£91.90	Stock



GEZE Retractable Arm Drive

The retractable arm drive has been designed for use on doors and is mounted on the hinge side or opposite hinge side.

Description	Part No	List Price	Usual Delivery
K600T 24v DC/1.4Amp/EV1 silver	GZ130059	£1394.91	1 Week
K600G 24v DC/1.4Amp/EV1 silver	GZ130057	£1394.91	1 Week
K600F 24v DC/1.4Amp/EV1 silver	GZ130151	£1394.91	1 Week
K600 T bracket	GZ130153	£102.38	1 Week
K600 R bracket	GZ130154	£124.72	1 Week
K600 G bracket	GZ130155	£125.80	1 Week



NOW ORDER ONLINE

FOR YOUR CONVENIENCE & SPEED

- ✓ Convenient ordering 24/7
- ✓ Check stock levels in real time
- ✓ View your order history

www.istsupplies.com



MAGNETIC DOOR RETAINERS

Type 87 - Wall Mounted

White ABS fire resistant casing c/w keeper plate. Approved to EN1155

Description	Part No	List Price	Usual Delivery
24vdc, 200N, 48mA	DR24-T87-200	£33.23	Stock
24vdc, 500N, 55mA	DR24-T87-500	£51.64	Stock
230vac, 200N, 5mA	DR230-T87-200	£36.30	Stock



Type 59 - Wall Mounted

White pressed steel fascia plate and back box, suitable for surface or flush fitting c/w keeper plate. Approved to EN1155



Description	Part No	List Price	Usual Delivery
24vdc, 200N, 48mA	DR24-T59-200	£37.65	Stock
230vac, 200N, 5mA	DR230-T59-200	£42.67	Stock

Accessories For Door Retainers

Description	Part No.	List Price	Usual Delivery
Floor mounting bracket	DR-FB2	£13.38	Stock
Chain mounting catch plates (PLATES ONLY - NO CHAIN SUPPLIED)	DR-CAP	£28.13	Stock
Chain mounting catch plates with protective rubber 'O' ring (PLATES ONLY - NO CHAIN SUPPLIED)	DR-CAP-O	£32.84	Stock
Chain mounting catch plates (C/W 1 METRE OF CHAIN)	DR-CAP-CHAIN	£52.11	Stock
Chain mounting catch plates with protective rubber 'O' ring (C/W 1 METRE OF CHAIN)	DR-CAP-O-CHAIN	£54.85	Stock
Spare catch plate, low profile, metal style	DRC-P	£12.96	Stock
Spare catch plate, adjustable, ABS plastic style	DRC-P-1	£12.96	Stock
Spare catch plate for 500N door retainers, low profile, metal style	DRC-P-2	£26.50	Stock

Type 84 - Floor Mounted

White cast aluminium construction c/w keeper plate. Tested to EN1155

Description	Part No	List Price	Usual Delivery
24vdc, 200N, 45mA	DR24-T84-200	£50.05	Stock
24vdc, 500N, 55mA	DR24-T84-500	£70.95	Stock



Decorative Door Retainers

Wall mounted, suitable for surface or flush fitting. Supplied with flush fitting back box and matching keeper plate. Colour matching back box sleeves available if surface fitting. Approved to EN1155



Description	Part No	List Price	Usual Delivery
24vdc, bright chrome, 48mA	DR24-T59-CHROME	£100.98	Stock
24vdc, lacquered brass, 48mA	DR24-T59-BRASS	£110.12	Stock
24vdc, stainless steel, 48mA	DR24-T59-STAINLESS	£100.98	Stock
230vac, bright chrome, 5mA	DR230-T59-CHROME	£119.76	Stock
230vac, lacquered brass, 5mA	DR230-T59-BRASS	£120.39	2 Weeks
230vac, stainless steel, 5mA	DR230-T59-STAINLESS	£120.54	2 Weeks
Chrome surface mounting sleeve	DR-SL-59-C	£26.22	Stock
Brass surface mounting sleeve	DR-SL-59-B	£30.50	Stock
Stainless steel surface mounting sleeve	DR-SL-59-S	£30.50	Stock

HEAVY DUTY DOOR RETAINERS

Universal Heavy Duty Door Retainers

24vdc, suitable for floor or wall mounting c/w keeper plate. Tested to EN1155

Description	Part No	List Price	Usual Delivery
500N, 200mm, 43mA	DR24-T79-05200	£96.41	Stock
500N, 300mm, 43mA	DR24-T79-05300	£97.45	Stock
1000N, 200mm, 76mA	DR24-T79-06200	£121.24	2 Weeks
1000N, 300mm, 76mA	DR24-T79-06300	£125.58	2 Weeks



WIRELESS DOOR CONTROL

Agrippa acoustic digital door control



The Agrippa acoustic door holder and door closer uses intelligent digital technology to learn the sound of your specific fire alarm, releasing or closing the door in the event of a fire.

New Agrippa vibrating pillow alarm now also available.



Other finishes now available - please enquire

AGRIPPA **NEW DUAL MODE**

New dual listening modes - fit straight from the box or program the device to listen and learn the sound of the fire alarm system.



Agrippa Acoustic Wireless Fire Products

Description	Part No.	List Price	Usual Delivery
Agrippa acoustic wireless door retainer	DR-AGRIPPA	£205.07	Stock
Floor mounting bracket for DR-AGRIPPA	DR-AG-FB	£11.83	Stock
Agrippa acoustic wireless door closer/hold open unit	DC-AGRIPPA	£503.50	Stock
Agrippa vibrating pillow alarm	VPA-AGRIPPA	£426.49	Stock



Salamander is a system of battery-powered, magnetic fire door holders and closers controlled by radio signals from a central controller. The range also includes a portable vibrating pillow alarm for alerting hearing impaired people in the event of a fire.

Important Note:
As with all radio equipment, a site survey and detailed report must be carried out by a suitably qualified person, prior to any installation. Please contact us for further details.

Salamander Radio Door Control Products

Description	Part No.	List Price	Usual Delivery
Salamander Control Panel	SAL-CP-0012	£445.19	1 Week
Salamander Door Closer - Right Hand	SAL-DC-0050	£602.69	1 Week
Salamander Door Closer - Left Hand	SAL-DC-0051	£602.69	1 Week
Salamander Magnetic Door Retainer c/w Keeper Plate	SAL-DR-0013	£361.62	1 Week
Salamander Extension Bracket 200mm	SAL-EB-S001	£68.45	1 Week
Salamander Extension Bracket 300mm	SAL-EB-S002	£71.17	1 Week
Salamander Extension Bracket 500mm	SAL-EB-S003	£77.98	1 Week
Salamander Floor Mounting Bracket	SAL-FB-S001	£23.93	1 Week
Salamander Signal Booster	SAL-SB-0014	£314.60	1 Week
Salamander Zleepsafe Vibrating Pillow Alarm	SAL-ZS-0040	£482.30	1 Week

ARROW ELECTRO MAGNETIC DOOR CLOSERS



Arrow 600 Series - Universal Electro Magnetic Door Closer

The Arrow 600 Series is a truly universal 24v electro magnetic door closer/hold open unit and can be installed in Pull Side (Figure 1), Push Side (Figure 6) or Transom Mount (Figure 61) as standard and is suitable for both left and right hand opening doors.

The unit has selectable hold open and free swing modes.

Description	Part No	List Price	Usual Delivery
Univ EM door closer, silver finish, power 3 (60Kg)	AR623EM-S-S	£288.54	1 Week
Univ EM door closer, silver finish, power 4 (80Kg)	AR624EM-S-S	£288.54	Stock
Univ EM door closer, brass finish, power 4 (80Kg)	AR624EM-S-B	£312.59	Stock

Other power ratings and finishes available, please enquire



Arrow BM3SE - Electro Magnetic Slide Arm Door Closer

The Arrow BM3SE is a fixed power 3 rack and pinion closer with electronic slide arm and is available in either Hold Open or Swing Free modes. Incorporates proprietary and patented Ease of Access opening technology to assist in meeting the requirements of the Equality Act 2010 and Building Regulations Document M.

Description	Part No	List Price	Usual Delivery
BM3SE Hold Open version, silver	BM3SEHO-SIL	£303.21	1 Week
BM3SE Free Swing version, silver	BM3SESF-SIL	£303.21	1 Week
BM3SE Hold Open version, satin stainless steel	BM3SEHO-SSS	£334.47	1 Week
BM3SE Free Swing version, satin stainless steel	BM3SESF-SSS	£334.47	1 Week



All Arrow door closers are available in a wide range of special finishes, please enquire (min order requirements apply)



ARROW MECHANICAL DOOR CLOSERS

Arrow 325 - Universal Door Closer

The Arrow 325 Universal Door Closer has adjustable variable power ratings 2 - 5 (40Kg to 100Kg) and can be installed in Pull Side (Figure 1), Push Side (Figure 6) or Transom Mount (Figure 61) as standard and is suitable for both left and right hand opening doors.

Description	Part No	List Price	Usual Delivery
Universal door closer, silver finish, variable power	AR325-S-S	£87.53	1 Week

Other finishes available, please enquire



Arrow BM3S - Fixed Power 3 Slide Arm Door Closer

Fixed Power 3 Rack and Pinion Slide Arm Closer available in Figure 1 (Pull Side) only configuration and incorporating the UK's most innovative Ease of Access technology.

Description	Part No	List Price	Usual Delivery
BM3S door closer, silver	BM3S-SIL	£106.28	1 Week
BM3S door closer, satin stainless steel	BM3S-SSS	£111.93	1 Week

Other finishes available, please enquire



ARROW DOOR CLOSERS



Arrow C24V - Concealed Cam Door Closer

Variable power 2-4 Concealed Cam action door closer. The ideal solution for applications requiring concealed door controls. Top plate thickness 32mm and unit can be used on doors up to 1100mm wide. Intumescent gasket pack included as standard

Description	Part No	List Price	Usual Delivery
Concealed cam door closer silver	C24V-SIL	£250.07	1 Week



Arrow FS14V - Floor Spring Door Closer

The FS14V Floor Spring is a versatile single or double action floor spring suitable for doors of all types up to 150kg and widths of up to 1100mm. Available with No Hold Open function or Hold Open past 90 degrees.

Description	Part No	List Price	Usual Delivery
Single action floor spring Non Hold Open	FS14VSANHO-SSS	£343.84	1 Week
Double action floor spring Non Hold Open	FS14VDANHO-SSS	£312.59	1 Week
Single action floor spring with Hold Open	FS14VSAHO-SSS	£343.84	1 Week
Double action floor spring with Hold Open	FS14VDAHO-SSS	£312.59	1 Week



GEZE ELECTRO MAGNETIC DOOR CLOSER

Geze TS4000E - Universal Electro Magnetic Door Closer

Rack & pinion door closer with electrohydraulic hold open device. 24vdc, closing force infinitely adjustable EN 1-6, can be used for right and left swing doors without conversion. Supplied with standard V arm or Swing Free arm.

Description	Part No	List Price	Usual Delivery
Geze EM door closer with std V arm, silver	TS4000E	£309.75	1 Week
Geze EM door closer with Swing Free arm, silver	TS4000EFS	£330.75	1 Week



BRITON ELECTRO MAGNETIC DOOR CLOSER

Briton 996 - Dual Function Fitting

24vdc, suitable for both left or right hand fitting. Hold open or free swing operation

Description	Part No	List Price	Usual Delivery
Application 1, size 3, pull side of door, 71mA	B996-F1	£330.22	Stock
Application 66, size 3, push side of door, 71mA	B996-F66	£377.39	Stock



EXIDOR ELECTRO DOOR CLOSER/HOLD OPEN UNITS

EXIDOR

DOOR CONTROLS

Unique plug-in power loop

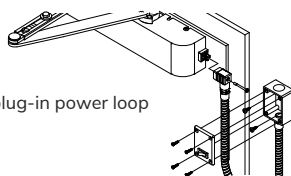

The Exidor 9870 E-mag is a fixed power size 4 electro-magnetic door closer supplied with matching adjustable arm and utilising the highly efficient cam & roller action. All Exidor E-mags have a unique plug in power loop for ease of fitting and offer universal fitting with brackets supplies for fig 1, fig 61 & fig 66 fixing.

All units are supplied with an adaptor which allows easy conversion from hold open to swing free mode

Exidor 9870 - Universal Electro Magnetic Door Closer

Description	Part No	List Price	Usual Delivery
9870 E-mag, radius cover, silver finish	EX9870R-SV	£276.52	Stock
9870 E-mag, radius cover, stainless steel finish	EX9870R-SS	£288.54	1 Week
9870 E-mag, square cover, silver finish	EX9870S-SV	£276.52	1 Week
9870 E-mag, square cover, stainless steel finish	EX9870S-SS	£288.54	1 Week

Other finishes available, please enquire



GUARDIAN CARE HOME SWING FREE ELECTRO MAGNETIC DOOR CLOSER

Guardian
by EXIDOR



Care Home Residents Door Closer....

Guardian by Exidor is a unique swing free door closer, developed specifically to meet the needs of care home facilities. In a class of its own the Guardian offers specific features that reduce the risk of injury to residents as well as eradicating the need to wedge doors open.

ANTI-SLAM FINGER PROTECTION:

The swing free mode of a closer can allow a door to slam shut. Regardless as to whether this is accidental, deliberate or just caused by a draught, it poses a real risk to frail residents and care home workers alike. Exidor's Guardian closer has been developed with an anti-slam function which controls and slows the motion of the door.

DRIFT RESISTANCE:

If a door is unbalanced it can naturally swing open or closed, or it can swing with a draught. This can result in a resident wedging the door open and invalidating it as a fire door. The Guardian closer offers a low level control on the door, which stops it from drifting from its open position, at the same time as allowing it to operate freely to the user.

The Guardian door closer is the only unit on the market specifically designed to meet the needs of residential care facilities.



- ✓ Unique swing free mechanism designed specifically for the needs of care accommodation
- ✓ Finger protecting anti-slam, prevents doors from being slammed shut
- ✓ Drift resistance from draughts and unbalanced doors
- ✓ Controlled swing speed in fire conditions
- ✓ Quality British manufacturing
- ✓ Approved to CE and Certifire

Guardian 9880 - Care Home Residents Door Closer With Anti Slam Feature

Description	Part No	List Price	Usual Delivery
Guardian door closer, radius cover, silver finish	EX9880R-SV	£324.61	1 Week
Guardian door closer, radius cover, s/steel finish	EX9880R-SS	£336.63	1 Week
Guardian door closer, square cover, silver finish	EX9880S-SV	£324.61	1 Week
Guardian door closer, square cover, s/steel finish	EX9880S-SS	£336.63	1 Week

Other finishes available, please enquire



FREEDOR SMARTSOUND WIRELESS OVERHEAD DOOR CLOSER

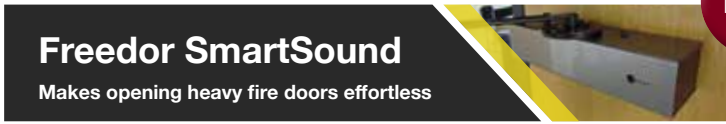

Freedor SmartSound

Makes opening heavy fire doors effortless

Freedor SmartSound is an overhead door closer which makes opening and closing a fire door effortless.

A wireless device, it allows you to place your door open in any position and closes on the sound of the alarm. As it is a free swing closer, the door is easy to push open without the usual resistance presented by a door closer.



Description	Part No.	List Price	Usual Delivery
Freedor SmartSound	FD2002	£641.55	1 Week

DORGARD SMARTSOUND WIRELESS DOOR HOLDERS



SmartSound listening technology means Dorgard SmartSound can distinguish between your fire alarm and common background noises, such as vacuum cleaners

Dorgard SmartSound is quick and easy to install

Dorgard SmartSound Wireless Door Holders

Description	Part No.	List Price	Usual Delivery
Dorgard SmartSound, black	DORGARD-SS-B	£216.41	1 Week
Dorgard SmartSound, white	DORGARD-SS-W	£216.41	1 Week

DORGARD WIRELESS DOOR HOLDERS



Dorgard enables you to safely hold fire doors open, allowing the door to close when the fire alarm sounds, preventing the spread of fire and smoke. The Dorgard requires no wiring as the unit is battery operated.



Dorgard Wireless Door Holders

Description	Part No.	List Price	Usual Delivery
Dorgard door retainer, black	DORGARD-BLK	£228.43	Stock
Dorgard door retainer, red	DORGARD-RED	£252.47	Stock
Dorgard door retainer, white	DORGARD-WHT	£252.47	Stock

MAGNETIC DOOR LOCKS

Mini Series Electro Magnetic Lock

Voltage: 12vdc/24vdc
 Holding Force: 280Kg/600lbs
 Current: 12vdc = 480mA ~ 24vdc = 240mA



Description	Part No	List Price	Usual Delivery
Single - aluminium	ML600	£39.94	Stock
Double - aluminium	ML600D	£87.88	Stock
Adjustable L bracket for 600 range	BK600L	£14.69	Stock
Adjustable Z & L bracket for 600 range	BK600ZL	£21.24	Stock

Standard Series Electro Magnetic Lock

Voltage: 12vdc/24vdc
 Holding Force: 545Kg/1200lbs
 Current: 12vdc = 480mA ~ 24vdc = 240mA



Description	Part No	List Price	Usual Delivery
Single - aluminium	ML1200	£81.59	Stock
Double - aluminium (monitored)	ML1200DM	£182.00	Stock
Adjustable L bracket for 1200 range	BK1200L	£17.11	Stock
Adjustable Z & L bracket for 1200 range	BK1200ZL	£36.09	Stock

POWER SUPPLIES

24v Power Supplies

24vdc transformer rectifier power supplies with integral load switching relays, ideal for powering 24v door retainers, closers and mag-locks

Description	Part No	List Price	Usual Delivery
TRX power supply, 24v dc, 0.7 amp	TRX0.7A-24	£73.51	Stock
TRX power supply, 24v dc, 1.0 amp	TRX1A-24	£91.89	Stock
TRX power supply, 24v dc, 2.5 amp	TRX2.5A-24	£107.20	Stock



Full range of battery charger/ power supplies
Page 17

EMERGENCY DOOR RELEASE MANUAL CALL POINTS

Door Release Call Points & Switches

Description	Part No	List Price	Usual Delivery
Green, single pole, break glass	MCP3A-G-SG	£18.37	Stock
Green, double pole, break glass	MCP4A-G-SG	£42.01	Stock
Green waterproof, single pole, break glass	WCP3A-G	£93.58	Stock
Green waterproof, double pole, break glass	WCP4A-G	£107.32	1 Week
Green, single pole, 2 pos key switch, key removeable in both positions	WGK20S12-SG	£30.33	Stock
Green, single pole, 2 pos key switch, key trapped in position 1	WGK21S12-SG	£28.89	Stock



Other variants available plus a range of exit buttons - please enquire

PROTECTIVE STEEL CAGES

Cages For Detectors

Description	Part No	List Price	Usual Delivery
175mm Di x 75mm D. For flush cable	STI-9604	£33.26	Stock
180mm Di x 115mm D. For surface cable	STI9605	£36.76	Stock

Cages For Sounders, Beacons & Bells

Description	Part No	List Price	Usual Delivery
95mm Di x 90mm D, small	STI9615	£39.65	1 Week
149mm Di x 127mm D, medium	STI9617	£38.78	Stock
198mm Di x 152mm D, large	STI9614	£46.30	Stock
210mm Di x 108mm D. For up to 8" bell	STI9602	£38.25	1 Week

Cages For Emergency Lights

Description	Part No	List Price	Usual Delivery
220mm H x 450mm W x 128mm D	STI9644	£78.57	1 Week
160mm H x 460mm W x 150mm D	STI9648	£257.40	1 Week

Cages For Beam Detectors

Description	Part No	List Price	Usual Delivery
For FFE Fireray 5000 controller	STI9841	£38.96	1 Week
For FFE Fireray 5000 detector head	STI9840	£27.16	1 Week

Many other sizes and shapes of cages available - please enquire

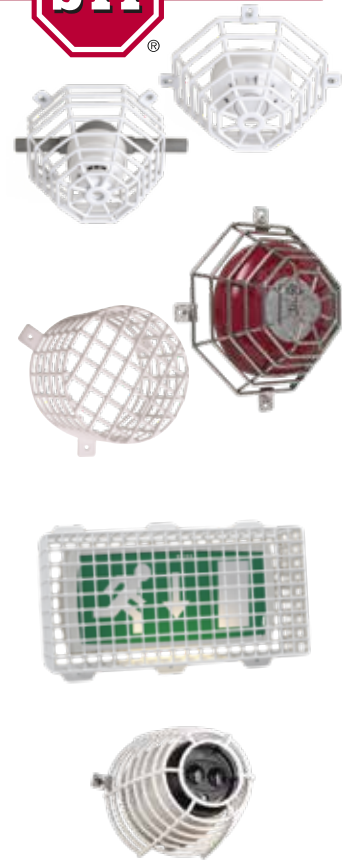
POLYCARBONATE COVERS
Thermostat Protective Covers

Description	Part No	List Price	Usual Delivery
Small thermostat protector, flush mount with frangible lock	STI9102	£24.29	1 Week
Medium thermostat protector, flush mount with key lock	STI9105	£32.79	1 Week
Large thermostat protector, flush mount with key lock	STI9110	£39.31	1 Week

Other protective polycarbonate covers available - please enquire

STOPPER ALARMS

Description	Part No	List Price	Usual Delivery
Exit Stopper emergency exit alarm	STI6400	£149.76	1 Week
Fire extinguisher theft Stopper	STI6200	£68.75	1 Week

Other variations available - please enquire

NOW ORDER ONLINE

FOR YOUR CONVENIENCE & SPEED

- ✓ Convenient ordering 24/7
- ✓ Check stock levels in real time
- ✓ View your order history

www.istsupplies.com



Self Contained Emergency Lighting

ELBH-LED-M3 LED EMERGENCY BULKHEAD



Specifications

- LED Light Source
- IP65 Protection Rating
- 3-Hour Emergency Duration
- Maintained Operation - Dual Circuit
- Tested to BS EN 69598-2-22

Description	Part No	List Price	Delivery
LED bulkhead	ELBH-LED-M3	£25.76	Stock

Supplied c/w self adhesive legend kit

B4L-LED-M3 SELF TEST LED EMERGENCY BULKHEAD



Specifications

- LED Light Source
- IP65 Protection Rating
- 3-Hour Emergency Duration
- Maintained Operation - Dual Circuit
- Tested to BS EN 69598-2-22
- Self Test Complies to BS EN-50172

Description	Part No	List Price	Delivery
Self test LED bulkhead	B4L-LED-M3	£48.09	1 Week
Self adhesive legend kit	B1L-LG	£1.82	Stock

ELEBD-LED-M3 LED EMERGENCY EXIT BOX



Specifications

- LED Light Source
- IP20 Protection Rating
- 36 Metre Viewing Distance
- 3-Hour Emergency Duration
- Maintained Operation - Dual Circuit
- Tested to BS EN 69598-2-22

Description	Part No	List Price	Delivery
LED exit box	ELEBD-LED-M3	£45.80	Stock
Left/Right legend	ELEBD-LGLR	£9.73	Stock

ELEBS-LED-M3 SLIMLINE LED EMERGENCY EXIT BOX



Specifications

- LED Light Source
- IP20 Protection Rating
- 36 Metre Viewing Distance
- 3-Hour Emergency Duration
- Maintained Operation - Dual Circuit
- Tested to BS EN 69598-2-22

Description	Part No	List Price	Delivery
Slimline LED exit box	ELEBS-LED-M3	£56.11	Stock

Supplied c/w arrow down & L/R legend pack

BE10 LED EMERGENCY HANGING EXIT SIGN



Specifications

- LED Light Source
- IP20 Protection Rating
- 36 Metre Viewing Distance
- 3-Hour Emergency Duration
- Maintained Operation - Dual Circuit
- Tested to BS EN 69598-2-22

Description	Part No	List Price	Delivery
BE10 LED hanging exit sign, white, arrow down	BE10-LED-M3-W	£66.98	1 Week
BE10 LED hanging exit sign, chrome, arrow down	BE10-LED-M3-C	£74.43	1 Week

BE3D-LED-M3 LED EMERGENCY HANGING EXIT SIGN



Specifications

- LED Light Source
- IP20 Protection Rating
- 36 Metre Viewing Distance
- 3-Hour Emergency Duration
- Maintained Operation - Dual Circuit
- Tested to BS EN 69598-2-22

Description	Part No	List Price	Delivery
BE3D hanging exit sign	BE3D-LED-M3-W	£64.12	Stock

BE3FR FULLY RECESSED EMERGENCY BLADE EXIT SIGN



Specifications

- LED or 8-Watt Fluorescent Tube
- 36 Metre Viewing Distance
- 3-Hour Emergency Duration
- Maintained Operation - Dual Circuit
- High Quality Engraved Legend
- Tested to BS EN 69598-2-22

Description	Part No	List Price	Delivery
Fully recessed exit blade, 8W, white, arrow down	BE3FR-8W-D-W	£131.85	1 Week
Fully recessed exit blade, LED, white, arrow down	BE3FR-LED-D-W	£145.30	1 Week

Available in brass & chrome and arrow L/R, please enquire

SPECTRUM SURFACE MOUNT OR RECESSED LED EM EXIT SIGN



Specifications

- LED Light Source
- 25 Metre Viewing Distance
- 3-Hour Emergency Duration
- Maintained Operation - Dual Circuit
- Tested to BS EN 60598-2-22

Description	Part No	List Price	Delivery
Spectrum LED exit sign, surface - c/w legend pack	SPECTRUM-M-1W-LED	£69.85	1 Week
Spectrum LED exit sign, recessed - c/w legend pack	SPECTRUM-R-1W-LED	£88.17	1 Week

ELTS-LED-D LED EMERGENCY TWINSPOOT - IP65



Specifications

- LED Light Source
- IP65 Protection Rating
- 3-Hour Emergency Duration
- Non Maintained Operation
- Tested to BS EN 69598-2-22
- Self Test Complies to BS EN 50172

Description	Part No	List Price	Delivery
Self test LED emergency twin spot	ELTS-LED-D	£105.91	Stock

BT3-LED-D INTERNAL LED EMERGENCY TWINSPOOT



Specifications

- LED Light Source
- IP20 Protection Rating
- 3-Hour Emergency Duration
- Non Maintained Operation
- Tested to BS EN 69598-2-22
- Self Test Complies to BS EN 50172

Description	Part No	List Price	Delivery
Internal LED emergency twin spot	BT3-LED-D	£59.54	Stock

B2D-LED-M3 EXTERNAL LED CIRCULAR EMERGENCY AMENITY LIGHT



Specifications

- 14.8 Watt LED Array
- IP65 Protection Rating
- 3-Hour Emergency Duration
- Maintained Operation - Dual Circuit
- Tested to BS EN 69598-2-22

Description	Part No	List Price	Delivery
B2D external LED circular amenity light	B2D-LED-M3	£144.27	1 Week

B2DS-LED-M3 EXTERNAL LED SQUARE EMERGENCY AMENITY LIGHT



Specifications

- 16 Watt Square LED Array
- IP65 Protection Rating
- 3-Hour Emergency Duration
- Maintained Operation - Dual Circuit
- Tested to BS EN 69598-2-22

Description	Part No	List Price	Delivery
B2D external LED square amenity light	B2DS-LED-M3	£161.45	1 Week

BD5D-LED-M3 EXTERNAL LED CIRCULAR EMERGENCY AMENITY LIGHT



Specifications

- 14.8 Watt LED Array
- IP65 Protection Rating
- 3-Hour Emergency Duration
- Maintained Operation - Dual Circuit
- Tested to BS EN 69598-2-22

Description	Part No	List Price	Delivery
BD5D external LED circular amenity light	BD5D-LED-M3	£94.18	1 Week

BD7-LED-M3 INTERNAL LOW PROFILE LED EM AMENITY LIGHT



Specifications

- 14.8 Watt LED Array
- IP20 Protection Rating
- 3-Hour Emergency Duration
- Maintained Operation - Dual Circuit
- Tested to BS EN 69598-2-22

Description	Part No	List Price	Delivery
Internal low profile circular amenity light	BD7-LED-M3	£144.27	1 Week

BC8 LED EMERGENCY DOWNLIGHTER



Specifications

- 1 x High Powered LED
- IP20 Protection Rating
- 3-Hour Emergency Duration
- Maintained Operation - Dual Circuit
- Tested to BS EN 69598-2-22
- Self Test Complies to BS EN 50172

Description	Part No	List Price	Delivery
BC8 LED emergency downlighter	BC8-2-3W-M3	£67.27	1 Week

NOW ORDER ONLINE

FOR YOUR CONVENIENCE & SPEED

- ✓ Convenient ordering 24/7
- ✓ Check stock levels in real time
- ✓ View your order history

www.istsupplies.com



FIRESCAPE LITE EMERGENCY LIGHTING



The emergency light that thinks for itself



NFW-SDT-DL2

Corridor Luminaire
£161.17



NFW-SDT-DL3

Open Space Luminaire
£158.60



NFW-SDT-NF89-C

High Powered Corridor Luminaire
£464.19



NFW-SDT-NF89-O

High Powered Open Space Luminaire
£483.53



NFW-SDT-EL20R

20mm Frame - Arrow Right Legend
£154.74



NFW-SDT-EL20D

20mm Frame - Arrow Down Legend
£154.74



NFW-SDT-EL20L

20mm Frame - Arrow Left Legend
£154.74



NFW-SDT-EL20U

20mm Frame - Arrow Up Legend
£154.74



NFW-SDT-EL40R

40mm Frame - Arrow Right Legend
£167.63



NFW-SDT-EL40D

40mm Frame - Arrow Down Legend
£167.63



NFW-SDT-EL40L

40mm Frame - Arrow Left Legend
£167.63



NFW-SDT-EL40U

40mm Frame - Arrow Up Legend
£167.63

Visit our brand new website: www.istsupplies.com



NOW ORDER ONLINE

FOR YOUR CONVENIENCE & SPEED

- ✓ Convenient ordering 24/7
- ✓ Check stock levels in real time
- ✓ View your order history
- ✓ Download invoices & statements



www.istsupplies.com

Sales

Tel: +44 (0) 1895 424505

Orders: orders@istsupplies.com

Sales enquiries: sales@istsupplies.com

Collections

Monday-Friday 08:30 ~ 16:30

IST Supplies Ltd: Unit 3 Horton Industrial
Park, West Drayton, UB7 8JD

Next day deliveries to UK
mainland, excluding highlands
& islands

Our full terms and conditions of sale are available from our website:
www.istsupplies.com



Connect with us

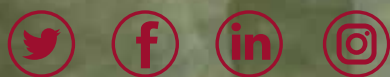

Published January 2022

IST Supplies Limited, Unit 3 Horton Industrial Park,
West Drayton, UB7 8JD, UK